

A close-up photograph of a red car's front end, focusing on the headlight and grille. The headlight is large and rectangular with a complex, multi-faceted lens. The grille is visible in the upper right corner, featuring a honeycomb pattern. The car's body is a vibrant red color.

2015 NEW ITEM FLYER  
COLLECTION



QUALITY.

INNOVATION.

DESIGN.

# MISSION STATEMENT

**HERE AT UNITED PACIFIC,** we are dedicated to providing today's drivers with innovative and exciting products that deliver exceptional performance and value. Because United Pacific's continuing success depends on our customer's satisfaction, we constantly push our designers and engineers to upgrade our facilities and processes in order to bring products of superior quality and reliability to the market. We at United Pacific promise to continue our passionate pursuit to be the first in:

QUALITY, INNOVATION AND DESIGN.

## QUALITY

With over 30 years of experience in the heavy duty trucking industry, United Pacific Industries understand the rigors and stresses that our products are subjected to on the road. It is our mission to provide our customers with products of superior quality and reliability. In achieving this goal, United Pacific only partners with manufacturing facilities that conforms to our quality control requirements and standards. Our manufacturing partners meet or exceed ISO-9001 requirements. In addition, United Pacific's manufacturing partners must be equipped on site to perform the following quality assurance tests:

- AGING TEST
- AIR TIGHT TEST
- DUST TEST
- FLUX TEST
- PHOTOMETRIC TEST
- PULL FORCE TEST
- RAIN TEST
- SALT SPRAY TEST
- SHOCK TEST
- TEMPERATURE TEST
- HUMIDITY TEST
- VIBRATION TEST



United Pacific's manufacturing partners must maintain a track record of consistent quality and low product failure rate. Furthermore, our internal quality control structure allows us to function as the final quality control station prior to shipping. With the assistance of 3D computer technology, United Pacific can adhere to strict quality control standards during prototype creation and the production process. Our engineers and technicians perform a battery of tests to ensure that our products meet the demands of today's drivers and our goal to be first in quality.





# ABOUT US

## DESIGN

Located near some of the nation's most progressive automotive design centers, United Pacific established the UP Design Studio in 2002 to consolidate our position as the design leader in the heavy duty trucking industry. UP Design Studio utilizes the latest generation of computer aided design (CAD) and studio/graphic software. The design studio is equipped with the newest computers and rapid prototyping systems. In addition, UP Design Studio is staffed by graduates from the nation's most prestigious design colleges.

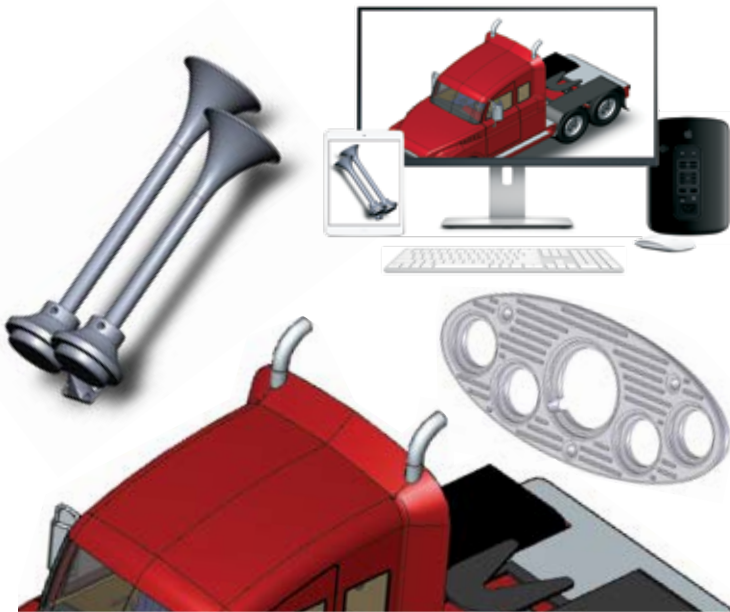

Unlike our competitors, United Pacific's design and manufacturing capabilities mean that we carry more new and original items than our competitors. The establishment of the design studio will enable us to generate even more new products with significant shorter concept-to-shelf time. The reduction in development cost mean that we can develop products utilizing design based development processes. Design based product development allows United Pacific to create new product concepts based on designs incorporating driver demands and needs instead of economic considerations. United Pacific's emphasis on design distinguishes and positions us ahead of our competitors.

## HOW TO ORDER

To order from United Pacific Industries, you must be an authorized dealer, distributor or OEM.

If you are not authorized to stock and sell United Pacific products, you must order through an authorized dealer. Please call 1 (800) 790-6988 for more information.

## CONTACT US

United Pacific customer service representatives are available from:

8 am - 4:30 pm PST

Toll Free: 1 (800) 790-6988  
 Fax: 1 (888) 986-5988  
 Email: [sales@uapac.com](mailto:sales@uapac.com)  
 Website: [www.uapac.com](http://www.uapac.com)

## INNOVATION

Known as the leader in innovation, United Pacific is dedicated to be the first to bring new and exciting products to the market. United Pacific's global expertise allows us to search the globe for new ideas and concepts. Not only do we search the globe for new products, United Pacific invest a significant amount of resources into our own research and development efforts. With the assistance of advance 3D scanning technology, our engineers and designers can acquire accurate and precise data in seconds. The 3D data allows United Pacific to verify designs, perform quality assurance tests, and reverse engineer with unprecedented speed and accuracy. Digital inspection contributes to the early detection of shape problems, provides rapid feedback on design, and eliminates unnecessary work in downstream processes. Our rapid prototyping facility permits us to have a concept-to-shelf time of less than 5 months. In addition, United Pacific's 3D printing capabilities permit our designers to have physical models of their design concepts in hours. The physical models allow our designers and marketing staff to evaluate and test the viability of different design ideas. Our rapid prototyping facility allow United Pacific to compress design cycles, improve manufacturing planning, shorten concept-to-shelf time, most importantly, generate new and innovative products.





## WARRANTY

With LED (Light Emitting Diodes) rated at 100,000 hours of operation and solid-state construction, United Pacific's LED lights are extremely reliable and durable. Purchase with confidence, United Pacific offers a complete line of LED lighting products with extended warranties. Please see the warranty policy page for more details.



## INVENTORY & SHIPPING

United Pacific carries over 20,000 items in our California distribution center. No other company in the heavy duty trucking industry can match United Pacific in the variety and range of in-stock inventories. With an order fill rate of over 98.5%, United Pacific is the largest and most reliable supplier in the industry. Our shipping department ships 96.8% of all orders within 24 hours and 98.9% within 48 hours. United Pacific's vast inventory and prompt shipping has made United Pacific the only source for our customer's chrome and lighting needs.



## ASSEMBLED IN U.S.A.

United Pacific strives to provide today's drivers with innovative and exciting products that deliver exceptional performance and value. With our international background and expertise, we search the globe for the best and most reliable products. However, as an American company, we believe and support the American way of life. Look for the "Assembled in the USA" label on many of our products. Although the components are manufactured overseas, the products, bearing the "Assembled in the USA" labels, are hand assembled with pride in the United States.

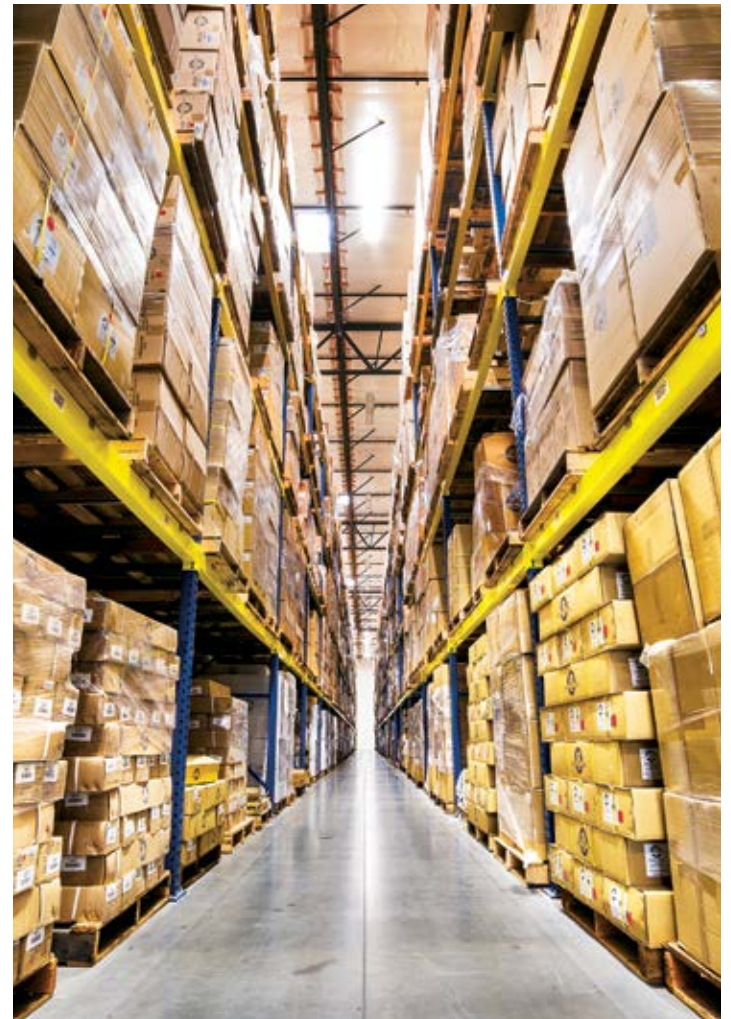

# Hard at Work for Our Customers. Hard at Work for the Environment



**United Pacific**  
**132,000** sq ft  
**Distribution Center**  
**Long Beach, CA**

**100%**

reduction in potable water used for landscaping

**40%**

reduction in total energy use due to high-efficiency mechanical and lighting systems

**82%**

of construction waste was diverted from landfills

## LEED ACCOMPLISHMENTS

### Sustainable Sites

- On-site bicycle storage, showers and changing areas for company employees
- Preferred parking for low-emitting, fuel-efficient and carpool vehicles
- Stormwater is infiltrated on-site and treated to remove contaminants to reduce environmental impact on local waterways

### Water Efficiency

- In addition to using reclaimed water, drought-tolerant plants and a high-efficiency irrigation system were installed to reduce the use of potable water for irrigation by 100%
- High-efficiency water closets, lavatory faucets, and showers were used to reduce annual water use by 30%

### Energy and Atmosphere

- Efficient HVAC equipment and a lighting system with daylight controls reduces energy consumption by over 30%
- Enhanced commission verifies that the building's energy and water-related systems are performing as intended by the initial design

### Materials and Resources

- Over 81% of construction and demolition waste was diverted from landfills

### Indoor Environmental Quality

- Building ventilation system was designed to provide enhanced levels of fresh outside air to building occupants
- Interior finishes (paints, sealants, adhesives, coatings, carpet systems and composite wood) were selected with low levels of volatile organic compounds (VOCs) to reduce indoor air contamination



# TABLE OF CONTENTS

## 2015 NEW ITEM SUPPLEMENT

<b>JAN</b>	JANUARY NEW ITEMS _____	2
<b>MARCH</b>	MARCH NEW ITEMS _____	10
<b>APRIL</b>	APRIL NEW ITEMS _____	20
<b>MAY</b>	MAY NEW ITEMS _____	21
<b>JUNE</b>	JUNE NEW ITEMS _____	25
<b>JULY</b>	JULY NEW ITEMS _____	29
<b>AUG</b>	AUGUST NEW ITEMS _____	37
<b>SEPT</b>	SEPTEMBER NEW ITEMS _____	43
<b>OCT</b>	OCTOBER NEW ITEMS _____	45
	OEM LIGHTING _____	51
<b>NOV</b>	NOVEMBER NEW ITEMS _____	57
<b>DEC</b>	DECEMBER NEW ITEMS _____	63
<b>INDEX</b>	TERMS & CONDITIONS _____	69
	PRODUCT INDEX _____	73

# WHAT'S NEW | JAN 2015

## 7 LED 4" "Competition Series" S/T/T Light

### Description

- 7 LED 4" "Competition Series" S/T/T Light
- Recommended Plug: Item # 34212/34216, **Lifetime Warranty**

Item Number	LEDs	Lens	Package	Pack
<b>39117B (NEW)</b>	7 Red	Red	Bulk	1 Pc.
<b>39117 (HOT)</b>	7 Red	Red	Carded	1 Pc./Card
<b>39118B (NEW)</b>	7 Red	Clear	Bulk	1 Pc.
<b>39118 (HOT)</b>	7 Red	Clear	Carded	1 Pc./Card



## 28 LED 12" Slim Light Bar

### Description

- 28 LED 12" Slim Light Bar
- Super Slim Profile Aluminum Housing, 3/8" Wide x 3/16" Tall
- Easy Installation, Double Side Tape Mount, Universal Application

Item Number	LEDs	Lens	Package	Pack
<b>36879 (NEW)</b>	28 Amber	Clear	Carded	1 Pc./Card
<b>36880 (NEW)</b>	28 Blue	Clear	Carded	1 Pc./Card
<b>36881 (NEW)</b>	28 Red	Clear	Carded	1 Pc./Card
<b>36882 (NEW)</b>	28 White	Clear	Carded	1 Pc./Card



## 14 LED 6" Slim Light Bar

### Description

- 14 LED 6" Slim Light Bar
- Super Slim Profile Aluminum Housing, 3/8" Wide x 3/16" Tall
- Easy Installation, Double Side Tape Mount, Universal Application

Item Number	LEDs	Lens	Package	Pack
<b>36875 (NEW)</b>	14 Amber	Clear	Carded	1 Pc./Card
<b>36876 (NEW)</b>	14 Blue	Clear	Carded	1 Pc./Card
<b>36877 (NEW)</b>	14 Red	Clear	Carded	1 Pc./Card
<b>36878 (NEW)</b>	14 White	Clear	Carded	1 Pc./Card



## Chrome Kenworth T600 Mirror Cover

### Description

- Chrome Mirror Cover for Kenworth T600
- Sold Individually, Please Specify Driver or Passenger Side

Item Number	Application	OEM Number	Pack
<b>21745B (NEW)</b>	Driver	R59-1019-22	1 Pc./Box
<b>21746B (NEW)</b>	Passenger	R59-1010-22	1 Pc./Box





# WHAT'S NEW | JAN 2015

## Stainless Peterbilt 379 Long Hood Model Bug Deflector

### Description

- Stainless Steel Bug Deflectors for Peterbilt 379 Long Hood Model Trucks
- Drilling of Mounting Holes through Hood Required
- Provides A Classy And More Forgiving Alternative to Plastic Bug Deflectors
- Installation Hardware Included

Item Number	Fits	Package	Pack
29000 (NEW)	Peterbilt 379 Long Hood	Boxed	1 Pc./Box



## Stainless Peterbilt 386 Bug Deflector

### Description

- Stainless Steel Bug Deflectors for Peterbilt 386 Trucks
- Drilling of Mounting Holes through Hood Required
- Provides A Classy And More Forgiving Alternative to Plastic Bug Deflectors
- Installation Hardware Included

Item Number	Fits	Package	Pack
29002 (NEW)	Peterbilt 386	Boxed	1 Pc./Box

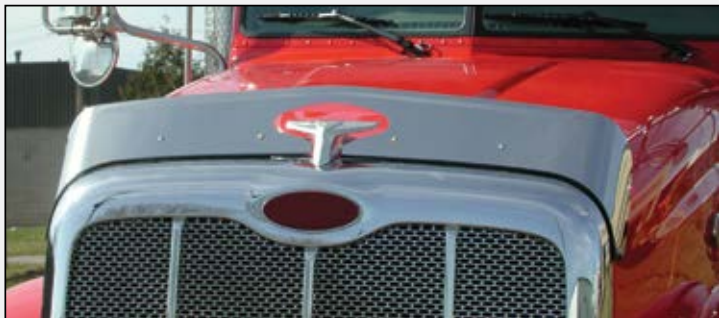

## Stainless 2013+ Peterbilt 579 Bug Deflector

### Description

- Stainless Steel Bug Deflectors for 2013+ Peterbilt 579 Trucks
- Drilling of Mounting Holes through Hood Required
- Provides A Classy And More Forgiving Alternative to Plastic Bug Deflectors
- Installation Hardware Included

Item Number	Fits	Package	Pack
29001 (NEW)	2013+ Peterbilt 579	Boxed	1 Pc./Box



## Stainless 2007+ Peterbilt 388/389/Heavy Haul 367 Bug Deflector

### Description

- Durable Stainless Steel Bug Deflectors for 2007+ Peterbilt 388/389/Heavy Haul 367 Trucks
- Drilling of Mounting Holes through Hood Required
- Provides A Classy And More Forgiving Alternative to Plastic Bug Deflectors
- Installation Hardware Included

Item Number	Fits	Package	Pack
29003 (NEW)	2007+ Peterbilt 388/389/367	Boxed	1 Pc./Box



## Stainless Kenworth T660 Bug Deflector

### Description

- Stainless Steel Bug Deflectors for Kenworth T660 Trucks
- Drilling of Mounting Holes through Hood Required
- Provides A Classy And More Forgiving Alternative to Plastic Bug Deflectors
- Installation Hardware Included

Item Number	Fits	Package	Pack
29005 (NEW)	Kenworth T660	Boxed	1 Pc./Box



## Stainless Kenworth T600 Bug Deflector

### Description

- Stainless Steel Bug Deflectors for Kenworth T600 Trucks
- Drilling of Mounting Holes through Hood Required
- Provides A Classy And More Forgiving Alternative to Plastic Bug Deflectors
- Installation Hardware Included

Item Number	Fits	Package	Pack
29004 (NEW)	Kenworth T600	Boxed	1 Pc./Box



## Stainless 2011+ Kenworth T700 Bug Deflector

### Description

- Stainless Steel Bug Deflectors for 2011+ Kenworth T700 Trucks
- Drilling of Mounting Holes through Hood Required
- Provides A Classy And More Forgiving Alternative to Plastic Bug Deflectors
- Installation Hardware Included

Item Number	Fits	Package	Pack
29006 (NEW)	2011+ Kenworth T700	Boxed	1 Pc./Box



## Stainless Kenworth T800 Bug Deflector

### Description

- Stainless Steel Bug Deflectors for Kenworth T800 Trucks
- Drilling of Mounting Holes through Hood Required
- Provides A Classy And More Forgiving Alternative to Plastic Bug Deflectors
- Installation Hardware Included

Item Number	Fits	Package	Pack
29007 (NEW)	Kenworth T800	Boxed	1 Pc./Box



# WHAT'S NEW | JAN 2015

## Stainless 2007+ Kenworth T800 Wide Hood & C500 Bug Deflector

### Description

- Stainless Steel Bug Deflectors for 2007+ Kenworth T800 Wide Hood And C500 Trucks
- Drilling of Mounting Holes through Hood Required
- Provides A Classy And More Forgiving Alternative to Plastic Bug Deflectors
- Installation Hardware Included

Item Number	Fits	Package	Pack
29008 (NEW)	2007+ Kenworth T800 Wide/C500	Boxed	1 Pc./Box



## Stainless 1993 - 2006 Kenworth T800 Wide Hood & C500 Bug Deflector

### Description

- Stainless Steel Bug Deflectors for 1993 - 2006 Kenworth T800 Wide Hood And C500 Trucks
- Drilling of Mounting Holes through Hood Required
- Provides A Classy And More Forgiving Alternative to Plastic Bug Deflectors
- Installation Hardware Included

Item Number	Fits	Package	Pack
29009 (NEW)	1993 - 2006 Kenworth T800/C500	Boxed	1 Pc./Box



## Stainless Kenworth W900L Bug Deflector

### Description

- Stainless Steel Bug Deflectors for Kenworth W900L Trucks
- Drilling of Mounting Holes through Hood Required
- Provides A Classy And More Forgiving Alternative to Plastic Bug Deflectors
- Installation Hardware Included

Item Number	Fits	Package	Pack
29011 (NEW)	Kenworth W900L	Boxed	1 Pc./Box



## Stainless Kenworth W900B Bug Deflector

### Description

- Stainless Steel Bug Deflectors for Kenworth W900B Trucks
- Drilling of Mounting Holes through Hood Required
- Provides A Classy And More Forgiving Alternative to Plastic Bug Deflectors
- Installation Hardware Included

Item Number	Fits	Package	Pack
29010 (NEW)	Kenworth W900B	Boxed	1 Pc./Box



## Stainless 2003+ Volvo VN Bug Deflector

### Description

- Stainless Steel Bug Deflectors for 2003+ Volvo VN Trucks
- Drilling of Mounting Holes through Hood Required
- Provides A Classy And More Forgiving Alternative to Plastic Bug Deflectors
- Installation Hardware Included

Item Number	Fits	Package	Pack
29012 (NEW)	2003+ Volvo VN	Boxed	1 Pc./Box



## Stainless Volvo Day Cab/420/610/660/770 Bug Deflector

### Description

- Stainless Steel Bug Deflectors for Volvo Day Cab/420/610/660/770 Trucks
- Drilling of Mounting Holes through Hood Required
- Provides A Classy And More Forgiving Alternative to Plastic Bug Deflectors
- Installation Hardware Included

Item Number	Fits	Package	Pack
29014 (NEW)	Volvo Day Cab/420/610/660/770	Boxed	1 Pc./Box



## Stainless Volvo 2003+ VN Bug and Grill Deflector Kit

### Description

- Stainless Steel Bug and Grill Deflector Kit for Volvo 2003+ 630/670/780 VN Trucks
- Four Piece Stainless Steel Bug and Grill Deflector Kit Surround the Grill
- Provide Full Frontal Protection from Road Debris
- Some Drilling Required, Installation Hardware Included

Item Number	Fits	Package	Pack
29013 (NEW)	2003+ Volvo VN	Boxed	1 Pc./Box



## Stainless International ProStar Bug Deflector

### Description

- Stainless Steel Bug Deflectors for International ProStar Trucks
- Drilling of Mounting Holes through Hood Required
- Mounts Behind Grill Bezel, Installation Hardware Included

Item Number	Fits	Package	Pack
29015 (NEW)	International Prostar	Boxed	1 Pc./Box



# WHAT'S NEW | JAN 2015

## Stainless International 9900 Series/5900I SFA Bug Deflector

### Description

- Stainless Bug Deflectors for International 9900 Series/5900I SFA Trucks
- Drilling of Mounting Holes through Hood Required
- Mounts Behind Grill Bezel, Installation Hardware Included

Item Number	Fits	Package	Pack
29016 (NEW)	International 9900 Series/5900I SFA	Boxed	1 Pc./Box

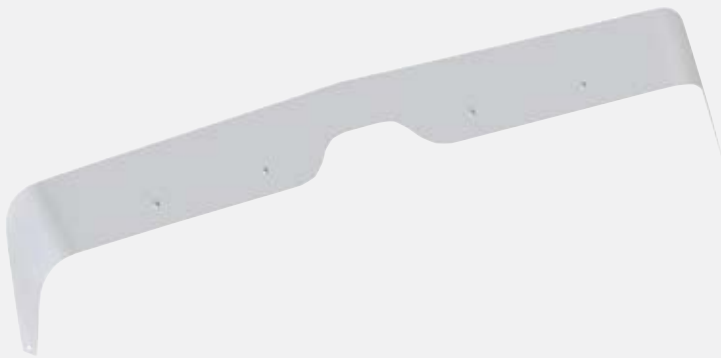

## Stainless 2002+ International 4000 Series Bug Deflector

### Description

- Stainless Steel Bug Deflectors for 2002+ International 4000 Series Trucks
- Drilling of Mounting Holes through Hood Required
- Mounts Behind Grill Bezel, Installation Hardware Included

Item Number	Fits	Package	Pack
29017 (NEW)	2002+ International 4000	Boxed	1 Pc./Box



## Stainless 2007+ Peterbilt 388 Hood Emblem Stripe Accent

### Description

- Stainless Steel Hood Emblem Stripe Accent for 2007+ Peterbilt 388 Trucks
- Emblem Accents Are Mounted Using Existing Emblem Mounting Studs
- 3M Two-Sided Tape Included, Sold in Pairs

Item Number	Fits	Package	Pack
29027 (NEW)	2007+ Peterbilt 388	Carded	1 Pair/Card

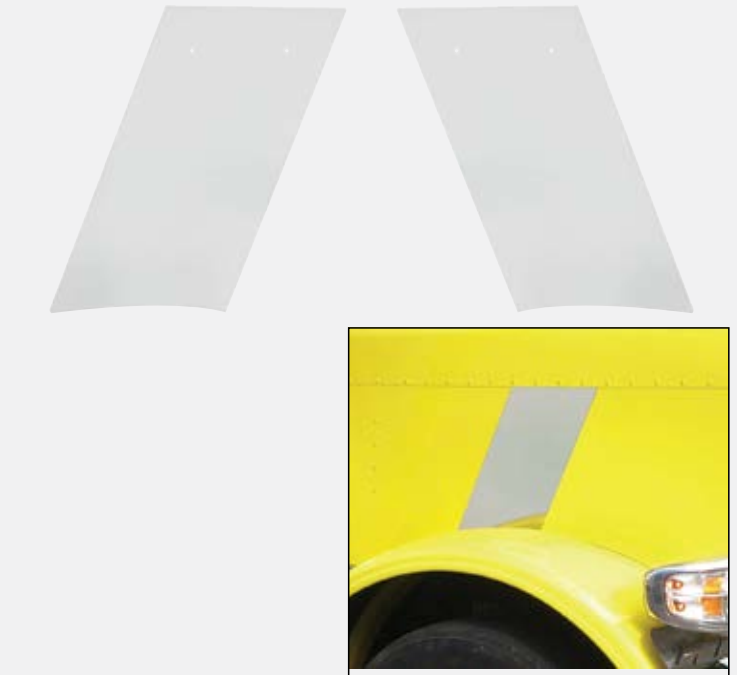

## Stainless 2007 Peterbilt 389 Hood Emblem Stripe Accent

### Description

- Stainless Steel Hood Emblem Stripe Accent for 2007 Peterbilt 389 Trucks
- Emblem Accents Are Mounted Using Existing Emblem Mounting Studs
- 3M Two-Sided Tape Included, Sold in Pairs

Item Number	Fits	Package	Pack
29028 (NEW)	2007 Peterbilt 389	Carded	1 Pair/Card



# WHAT'S NEW | JAN 2015

## Stainless 2007+ Kenworth T660/T370 Hood Logo Trim

### Description

- Stainless Steel Hood Logo Trim for 2007+ Kenworth T660/T370 Trucks
- Attaches Using Supplied 3M Two-Sided Tape, Sold in Pairs

Item Number	Fits	Package	Pack
<b>29052 (NEW)</b>	2007+ Kenworth T660/T370	Carded	1 Pair/Card

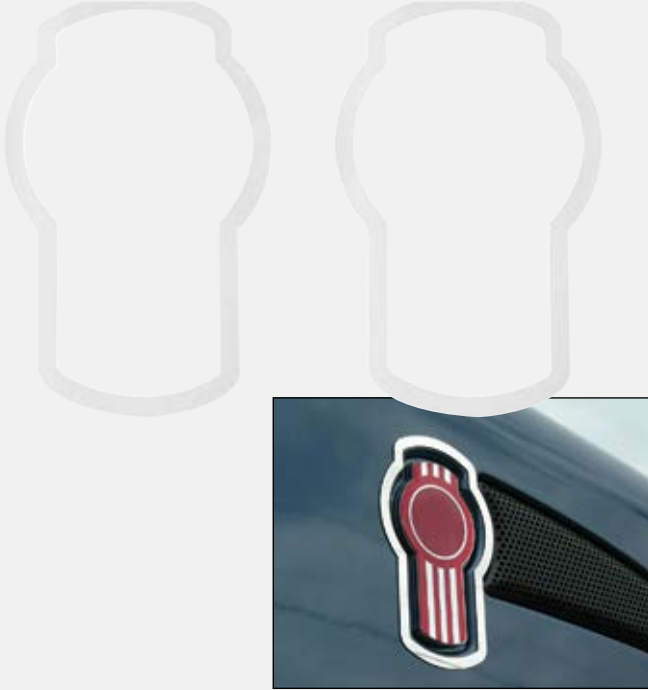

## Stainless 2008+ Kenworth T660/T370 Air Intake Logo Trim

### Description

- Stainless Steel Air Intake Logo Trim for 2008+ Kenworth T660/T370 Trucks
- Attaches Using Supplied 3M Two-Sided Tape, Sold in Pairs

Item Number	Fits	Package	Pack
<b>29051 (NEW)</b>	2008+ Kenworth T660/T370	Carded	1 Pair/Card



## Stainless 2013+ Peterbilt 579 Intake Grill

### Description

- Stainless Steel Intake Grill for 2013+ Peterbilt 579 Trucks
- Sold in Pairs, 1 Pair/Card

Item Number	Fits	Package	Pack
<b>29021 (NEW)</b>	2013+ Peterbilt 579	Carded	1 Pair/Card



## Volvo VNL Hood Air Intake Grill

### Description

- Black Hood Air Intake Grill for Volvo VNL. Fits 2003+ Volvo VN Models
- Sold Individually, Please Specify Driver or Passenger Side

Item Number	Application	OEM Number	Pack
<b>41679 (NEW)</b>	Driver	85104902	1 Pc./Box
<b>41680 (NEW)</b>	Passenger	85104903	1 Pc./Box



## Stainless Kenworth T600/T800 Air Intake Cover

### Description

- Stainless Steel Air Intake Cover for Kenworth T600/T800 Trucks
- Attractive Stainless Steel Replacement for Factory Air Intake Cover
- Installation Hardware Included

Item Number	Description	Package	Pack
<b>29040 (NEW)</b>	Stainless Air Intake Cover	Carded	1 Pc./Card

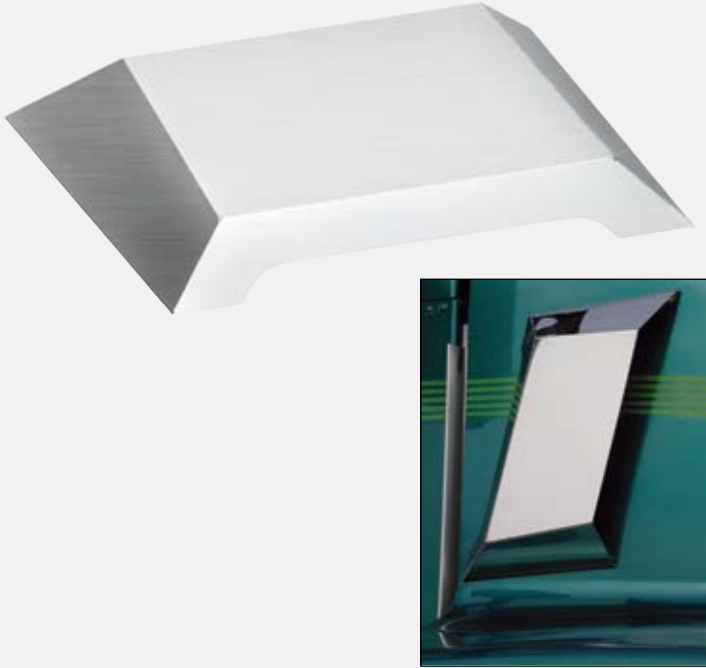

## Stainless Swing Away Mirror

### Description

- Low Mount Truck Mirror for Left and Right Hand Application
- Fits Most Pickups, Vans, Smaller RVs, and Campers
- Stainless Steel Mirror Housing, Arms, and Yoke
- Extendable to 15", Double Strength Stainless Tubing Reduces Vibration
- Swing-Away Function Helps Vehicle Fit into Those Tight Parking Spots

Item Number	Description	Package	Pack
<b>60039 (NEW)</b>	Swing Away Mirror	Boxed	1 Pc./Box

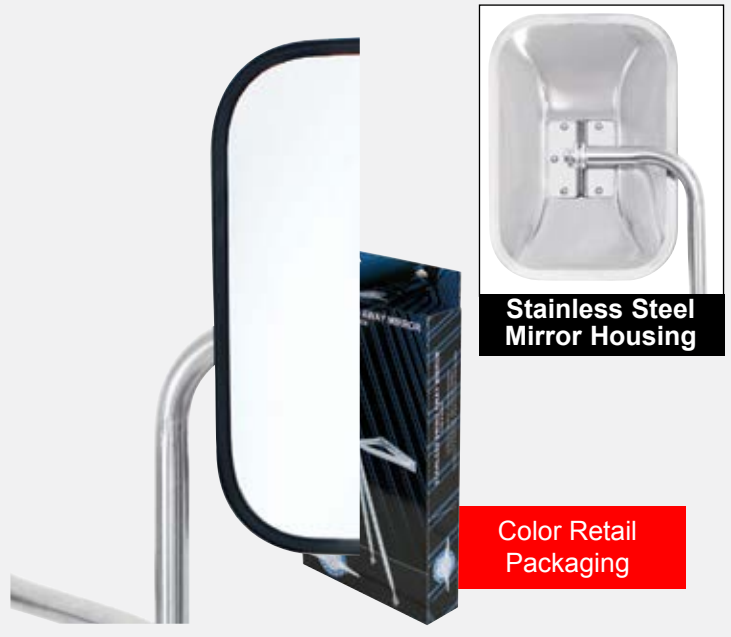

## Stainless Kenworth T700 Bunk Vent Cover Trim Kit

### Description

- Stainless Steel Bunk Vent Cover Trim Kit for Kenworth T700 Trucks
- The Bunk Vent Cover Consists of the Vent Cover and Outer Trim Ring
- Attaches Using Supplied 3M Two-Sided Tape, Sold As A 2-Piece Kit

Item Number	Fits	Package	Pack
<b>29045 (NEW)</b>	Kenworth T700	Carded	1 Set/Card



## Chrome Rear Axle Cover Replacement Hub Cap

### Description

- Chrome Plastic Rear Hub Cap for United Pacific Rear Axle Cover Kit
- Fits **United Pacific Rear Axle Cover Kit Item # 10263** with United Pacific Logo on the Back of the Hub Cap

Item Number	Description	Package	Pack
<b>10263-1Y (NEW)</b>	Dome Rear Hub Cap Only	Bulk	1 Pc



## LED Peterbilt Oval Front Fender Turn Signal Light

### Description

- 10 LED Oval Front Fender Turn Signal Light for Peterbilt, Fits Peterbilt 386 Models
- Available in Amber or Clear Lens, **Lifetime Warranty**
- Replace **OEM Part Number: P54-6008-111**

Item Number	LEDs	Lens	Package	Pack
<b>36873 (NEW)</b>	10 Amber	Amber	Carded	1 Pc./Card
<b>36874 (NEW)</b>	10 Amber	Clear	Carded	1 Pc./Card



## 6 LED 1" Warning Light - Split Color

### Description

- 6 LED 1" Warning Light, Split Color
- Amber / White LED on One Unit
- 12V Application, 19 Flash Pattern, Multiple Light Synchronization, Grommet Mounts into any 1" Opening
- Each Box Contains 2 Sets of 1" LED Mini Warning Light

Item Number	Description	Package	Pack
<b>37000 (NEW)</b>	1" Warning / Strobe Light	Carded	2 Sets/Box



## 24VDC to 12VDC Step Down Module

### Description

- Input 24VDC, Output 12VDC, Step Down Module
- Allows for the Installation of 12VDC LED Lights on 24VDC Vehicles
- Maximum of 1 AMP Load, One Module Can Operate Approximately 10 Clearance / Marker Light or 6 S/T/T Lights

Item Number	Description	Package	Pack
<b>90658 (NEW)</b>	24VDC to 12VDC Module	Carded	1 Pc./Card



## Peterbilt 387, 587 & Kenworth T2000, T700 Chrome Mirror Assembly

### Description

- Chrome Mirror Assembly for Peterbilt 387, 587 & Kenworth T2000, T700 Series
- Includes Complete Mirror and Mounting Arm
- Electric Operation with Heat, Chrome Mirror Cover
- Sold Individually, Please Specify Driver or Passenger Side

Item Number	Description	Application	Pack
<b>42773 (NEW)</b>	Chrome Mirror Assembly	Driver	1 Pc./Box
<b>42774 (NEW)</b>	Chrome Mirror Assembly	Passenger	1 Pc./Box





## Stainless 2007+ Kenworth T800 Curved Glass Models Fender Guards

### Description

- Stainless Steel Fender Guards for 2007+ Kenworth T800 Curved Glass Trucks
- Shield and Protect Your Fenders from Common Road Debris While Adding A Touch of Class
- Drilling Required, Hardware Included
- 430 Stainless Steel, Sold in Pairs

Item Number	Description	Package	Pack
29043 (NEW)	Stainless Fender Guards	Boxed	1 Pair/Box

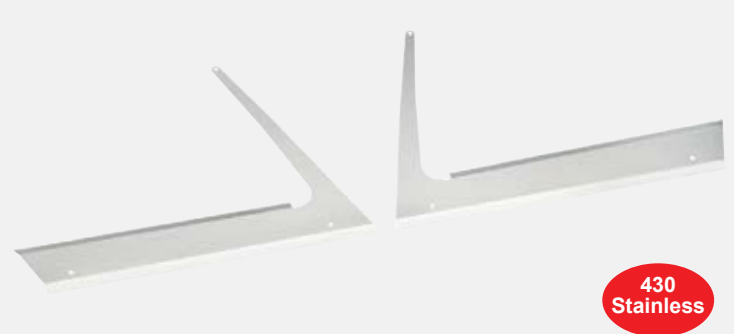

## Stainless Kenworth T800 Aerocab Fender Guards

### Description

- Stainless Steel Under Headlight Fender Guards for Kenworth T800 Aerocab Trucks
- Shield and Protect Your Fenders from Common Road Debris While Adding A Touch of Class
- Drilling Required, Hardware Included
- 430 Stainless Steel, Sold in Pairs

Item Number	Description	Package	Pack
29044 (NEW)	Stainless Fender Guards	Carded	1 Pair/Card



## Stainless Kenworth T600 Above Headlight Fender Guards

### Description

- Stainless Steel Above Headlight Fender Guards for Kenworth T600 Trucks
- Drilling Required, Hardware Included
- 430 Stainless Steel, Sold in Pairs

Item Number	Description	Package	Pack
29041 (NEW)	Above Headlight Fender Guards	Carded	1 Pair/Card



## Stainless Kenworth T600 Below Headlight Fender Guards

### Description

- Stainless Steel Below Headlight Fender Guards for Kenworth T600 Trucks
- Drilling Required, Hardware Included
- 430 Stainless Steel, Sold in Pairs

Item Number	Description	Package	Pack
29042 (NEW)	Below Headlight Fender Guards	Carded	1 Pair/Card



## Stainless International ProStar Fender Guards

### Description

- Stainless Steel Fender Guards for International ProStar Trucks
- Attaches Using Supplied 3M Two-Sided Tape
- 430 Stainless Steel, Sold in Pairs

Item Number	Description	Package	Pack
<b>29070 (NEW)</b>	ProStar Fender Guards	Boxed	1 Pair/Box



430  
Stainless



## Stainless Kenworth T660 Fender Light Trim

### Description

- Stainless Steel Fender Light Trim for Kenworth T660 Trucks
- Attaches Using Supplied 3M Two-Sided Tape
- 430 Stainless Steel, Sold in Pairs

Item Number	Description	Package	Pack
<b>29056 (NEW)</b>	T660 Fender Light Trim	Carded	1 Pair/Card



430  
Stainless



## Stainless Peterbilt 387, 2011+ Peterbilt 587 & Kenworth T700 Door Window Accent

### Description

- Stainless Steel Door Window Accent for Peterbilt 387, 2011+ Peterbilt 587 and Kenworth T700 Trucks
- Attaches Below the Passenger and Driver Door Window
- 430 Stainless Steel
- Attaches Using Supplied 3M Two-Sided Tape, Sold in Pairs

Item Number	Fits	Package	Pack
<b>29046 (NEW)</b>	Peterbilt 387 2011+ Peterbilt 587 Kenworth T700	Carded	1 Pair/Card



430  
Stainless



## Stainless Peterbilt 579 Door Window Accent

### Description

- Stainless Steel Door Window Accent for Peterbilt 579 Trucks
- 430 Stainless Steel
- Attaches Using Supplied 3M Two-Sided Tape, Sold in Pairs

Item Number	Description	Package	Pack
<b>29026 (NEW)</b>	579 Door Window Accent	Carded	1 Pair/Card



430  
Stainless



# WHAT'S NEW | MAR 2015

## Stainless Peterbilt 567/579 Door Handle Trim

### Description

- Stainless Steel Door Handle Trim for Peterbilt 567/579 Trucks
- Attaches Using Supplied 3M Two-Sided Tape
- 430 Stainless Steel, Sold in Pairs

Item Number	Description	Package	Pack
29025 (NEW)	Stainless Door Handle Trim	Cared	1 Pair/Card



## Stainless Peterbilt 386 Front Step Trims

### Description

- Stainless Steel Front Step Trims for Peterbilt 386 Models
- Attaches Using Supplied 3M Two-Sided Tape
- 430 Stainless Steel, Sold in Pairs

Item Number	Fits	Package	Pack
29020 (NEW)	Stainless Front Step Trims	Boxed	1 Pair/Box

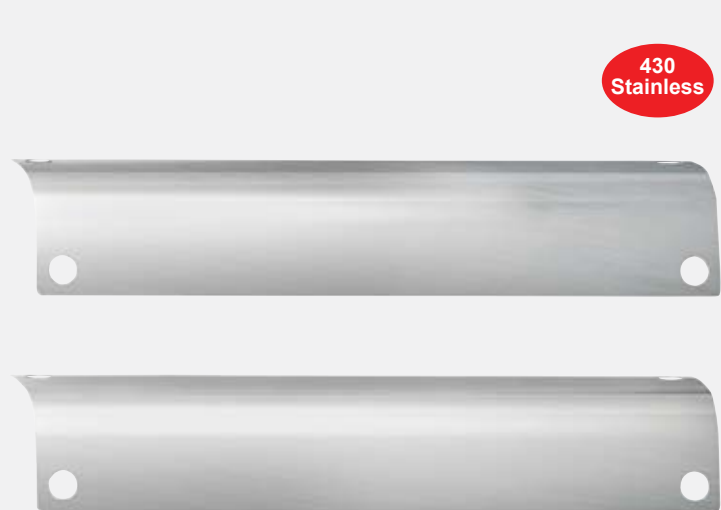

## Stainless Peterbilt 579 Front Step Trim

### Description

- Stainless Steel Front Step Trim for Peterbilt 579 Trucks
- Attaches Using Supplied Hardware and 3M Two-Sided Tape
- 430 Stainless Steel, Sold in Pairs

Item Number	Description	Package	Pack
29024 (NEW)	Top Front Kick Panel	Carded	1 Pair/Card



## Stainless Peterbilt 579 Back Step Trim

### Description

- Stainless Steel Back Step Trim for Peterbilt 579 Trucks
- Attaches Using Supplied Hardware and 3M Two-Sided Tape
- 430 Stainless Steel
- Sold in Pairs, Please Specify Upper or Lower Step Trim

Item Number	Description	Package	Pack
29023 (NEW)	Upper Back Step Trim	Carded	1 Pair/Card
29022 (NEW)	Lower Back Step Trim	Boxed	1 Pair/Box



## Stainless 2010+ Kenworth T660 (EPA) Front Upper Step Kick Plate

### Description

- Stainless Steel Front Upper Step Kick Plate for 2010+ Kenworth T660 (EPA) Trucks
- Attaches Using Supplied Hardware to the Upper Step
- 430 Stainless Steel, Sold in Pairs

Item Number	Description	Package	Pack
29054 (NEW)	Front Upper Step Kick Plate	Boxed	1 Pair/Box



430  
Stainless



## Stainless 2007-09 Kenworth T660 Front Upper Step Kick Plate

### Description

- Stainless Steel Front Upper Step Kick Plate for 2007-09 Kenworth T660 Trucks
- Attaches Using Supplied Hardware to the Upper Step
- 430 Stainless Steel, Sold in Pairs

Item Number	Description	Package	Pack
29053 (NEW)	Front Upper Step Kick Plate	Boxed	1 Pair/Box



430  
Stainless



## Stainless 2007+ Kenworth T660 Front Lower Step Kick Plate

### Description

- Stainless Steel Front Lower Step Kick Plate for 2007+ Kenworth T660 Trucks
- Attaches Using Supplied Hardware to the Lower Step
- 430 Stainless Steel, Sold in Pairs

Item Number	Fits	Package	Pack
29055 (NEW)	2007+ Kenworth T660	Boxed	1 Pair/Box



430  
Stainless

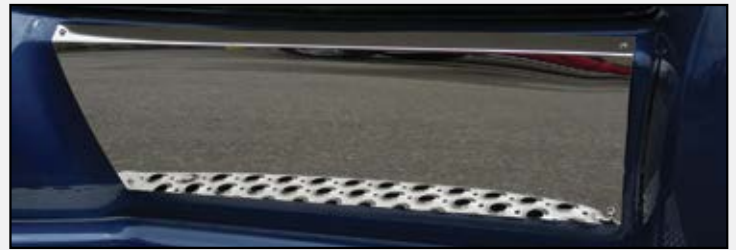

## Stainless Kenworth T700 Front Upper Step Kick Plate

### Description

- Stainless Steel Front Upper Step Kick Plate for Kenworth 700 Trucks
- 430 Stainless Steel
- Hardware Included, Sold in Pairs

Item Number	Description	Package	Pack
29048 (NEW)	Front Upper Step Kick Plate	Boxed	1 Pair/Box



430  
Stainless



# WHAT'S NEW | MAR 2015

## Stainless Kenworth T700 Front Lower Step Kick Plate

### Description

- Stainless Steel Front Lower Step Kick Plate for Kenworth T700 Trucks
- 430 Stainless Steel
- Hardware Included, Sold in Pairs

Item Number	Description	Package	Pack
29047 (NEW)	Front Lower Step Kick Plate	Boxed	1 Pair/Box



430  
Stainless



## Stainless 2007+ Kenworth T660, T680, T700 Back Lower Step Kick Plate

### Description

- Stainless Steel Back Lower Step Kick Plate for 2007+ Kenworth T660, T680, T700 Trucks
- 430 Stainless Steel
- Attaches Using Supplied Hardware and 3M Two-Sided Tape, Sold in Pairs

Item Number	Description	Package	Pack
29049 (NEW)	Back Lower Step Kick Plate	Boxed	1 Pair/Box



430  
Stainless



## Stainless 2007+ Kenworth T660, T680, T700 Back Upper Step Kick Plate

### Description

- Stainless Steel Back Upper Step Kick Plate for 2007+ Kenworth T660, T680, T700 Trucks
- 430 Stainless Steel
- Attaches Using Supplied Hardware and 3M Two-Sided Tape, Sold in Pairs

Item Number	Description	Package	Pack
29050 (NEW)	Back Upper Step Kick Plate	Boxed	1 Pair/Box



430  
Stainless



## Stainless 2003+ Volvo VN Front Upper Fairing Kick Plate

### Description

- Stainless Steel Front Upper Fairing Kick Plate for 2003+ Volvo VN Trucks
- Protects Painted Finish from Everyday Wear and Tear of Entering Into the Truck
- 430 Stainless Steel
- Attaches Using Supplied Hardware, Sold in Pairs

Item Number	Description	Package	Pack
29064 (NEW)	Front Upper Fairing Kick Plate	Boxed	1 Pair/Box



430  
Stainless



## Stainless 2006+ Volvo VNL Front Lower Step Kick Plate

### Description

- Stainless Steel Front Lower Step Kick Plate for Volvo 2006+ VNL Trucks
- 430 Stainless Steel
- Attaches Using Supplied Hardware and 3M Two-Sided Tape, Sold in Pairs

Item Number	Description	Package	Pack
29060 (NEW)	Front Lower Step Kick Plate	Carded	1 Pair/Card



430  
Stainless



## Stainless 2003+ Volvo VN Front Lower Step Kick Plate

### Description

- Stainless Steel Front Lower Step Kick Plate for Volvo 2003+ VN Trucks
- 430 Stainless Steel
- Attaches Using Supplied Hardware and 3M Two-Sided Tape, Sold in Pairs

Item Number	Description	Package	Pack
29062 (NEW)	Front Lower Step Kick Plate	Carded	1 Pair/Card



430  
Stainless

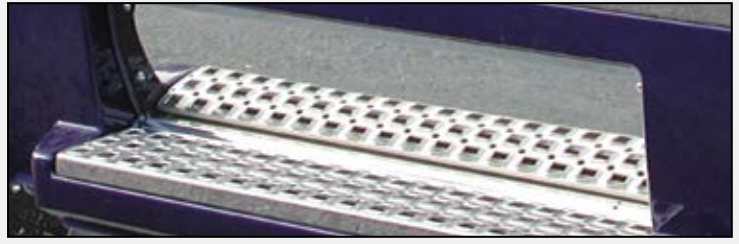

## Stainless 2003+ Volvo VN Back Lower Step Kick Plate

### Description

- Stainless Steel Lower Rear Step Insert for 2003+ Volvo VN Trucks
- 430 Stainless Steel
- Attaches Using Supplied Hardware, Sold in Pairs

Item Number	Description	Package	Pack
29063 (NEW)	Back Lower Step Kick Plate	Carded	1 Pair/Card



430  
Stainless



## Stainless 2006+ Volvo VNL Back Lower Step Kick Plate

### Description

- Stainless Steel Back Lower Step Kick Plate for Volvo 2006+ VNL Trucks
- 430 Stainless Steel
- Attaches Using Supplied Hardware and 3M Two-Sided Tape, Sold in Pairs

Item Number	Description	Package	Pack
29061 (NEW)	Back Lower Step Kick Plate	Carded	1 Pair/Card



430  
Stainless



# WHAT'S NEW | MAR 2015

## Stainless 2003+ Volvo VN License Plate Holder

### Description

- Stainless Steel License Holder for 2003+ Volvo VN Trucks
- Attaches Using Supplied Hardware
- License Plate Bezels Included
- 430 Stainless Steel
- Please Specify One or Two License Plate Holder

Item Number	Description	Package	Pack
29065 (NEW)	1 Plate Holder	Boxed	1 Pc./Box
29066 (NEW)	2 Plate Holder	Boxed	1 Pc./Box



29065



430  
Stainless



29066



## Stainless 2011+ Volvo EPA Urea Tank Filler Cover Panel

### Description

- Stainless Steel Urea Tank Filler Cover Panel for 2011+ Volvo EPA Trucks
- 430 Stainless Steel
- Drilling Required, Hardware Included

Item Number	Fits	Package	Pack
29067 (NEW)	2011+ Volvo EPA	Boxed	1 Pc./Box



430  
Stainless



## Stainless Kenworth T700 Bunk Vent Cover Trim Kit

### Description

- Stainless Steel Bunk Vent Cover Trim Kit for Kenworth T700 Trucks
- The Bunk Vent Cover Consists of the Vent Cover and Outer Trim Ring
- 430 Stainless Steel
- Attaches Using Supplied 3M Two-Sided Tape, Sold As A 2-Piece Kit

Item Number	Fits	Package	Pack
29045 (HOT)	Kenworth T700	Carded	1 Set/Card



430  
Stainless



## Stainless International ProStar/LoneStar Louvered Vent Covers

### Description

- Stainless Steel Louvered Vent Covers for International ProStar/LoneStar Trucks
- 430 Stainless Steel
- Attaches Using Supplied 3M Two-Sided Tape, Sold in Pairs

Item Number	Description	Package	Pack
29071 (NEW)	Louvered Vent Covers	Carded	1 Pair/Card



430  
Stainless



## Stainless International ProStar Fuel Filler Insert Trim

### Description

- Stainless Steel Fuel Filler Insert Trim for International ProStar Trucks
- 430 Stainless Steel
- Attaches Using Supplied 3M Two-Sided Tape, Sold in Pairs

Item Number	Description	Package	Pack
29073 (NEW)	Fuel Filler Insert Trim	Carded	1 Pair/Card

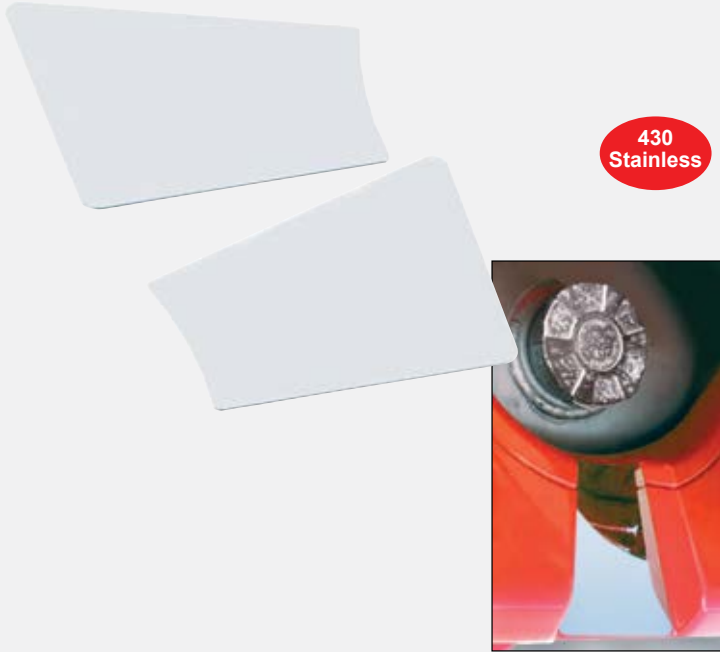

## Stainless International Backup Light Bracket

### Description

- Stainless Steel Backup Light Bracket for International Trucks
- 430 Stainless Steel
- Hardware Not Included, Sold in Pairs

Item Number	Description	Package	Pack
29072 (NEW)	Stainless Backup Light Bracket	Boxed	1 Pair/Box



## PAR 36 Rubber Work Light

### Description

- Durable Synthetic Rubber Housing Resists Corrosion
- Rubber Housing Cushions Trapezoidal Seal Beam from Shock and Vibration
- Mounts on Swivel Base Bracket
- Universal 5/16" Mounting Stud
- Mounting Hardware Allows Mounting in Any Position

Item Number	LEDs	Function	IP Rating	Pack
36451 (HOT)	3 Watt x 9	Flood	IP67	1 Pc./Card



## 18" Black Diamond Stitched Leather Steering Wheel Cover

### Description

- 18 " Black Diamond Stitched Leather Steering Wheel Cover

Item Number	Description	Package	Pack
70118 (NEW)	Black Diamond Stitching	Carded	1 Pc./Card
70119 (NEW)	Blue Diamond Stitching	Carded	1 Pc./Card
70120 (NEW)	Red Diamond Stitching	Carded	1 Pc./Card

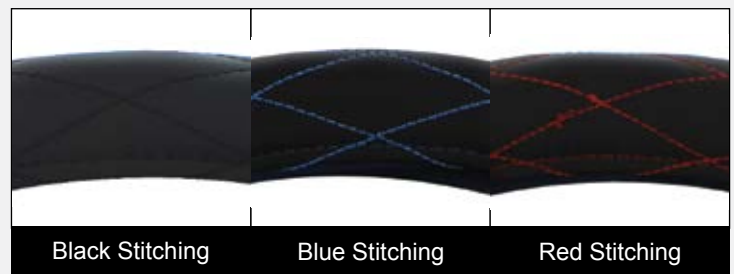



## 21 LED 3 1/4" Round Harley Signal Light with Housing

### Description

- 21 LED 3 1/4" Round Harley Signal Light with Housing
- Fits Original Harley Davidson Housing, Fits Various Years & Models
- Available with 1156 (Single Function) or 1157 (Dual Function) Plug
- Load Resistor (UP Item # 34205) Maybe Required for Proper Installation

Item Number	LEDs	Lens	Plug	Pack
31210 (NEW)	21 Amber	Amber	1156	1 Pc./Box
31211 (NEW)	21 Amber	Clear	1156	1 Pc./Box
31212 (NEW)	21 Amber	Smoke	1156	1 Pc./Box
31213 (NEW)	21 Red	Red	1156	1 Pc./Box
31214 (NEW)	21 Red	Clear	1156	1 Pc./Box
31215 (NEW)	21 Red	Smoke	1156	1 Pc./Box
31216 (NEW)	21 Amber	Amber	1157	1 Pc./Box
31217 (NEW)	21 Amber	Clear	1157	1 Pc./Box
31218 (NEW)	21 Amber	Smoke	1157	1 Pc./Box
31219 (NEW)	21 Red	Red	1157	1 Pc./Box
31220 (NEW)	21 Red	Clear	1157	1 Pc./Box
31221 (NEW)	21 Red	Smoke	1157	1 Pc./Box



## 21 LED 3 1/4" Round Harley Signal Light

### Description

- 21 LED 3 1/4" Round Harley Signal Light
- Fits Original Harley Davidson Housing, Fits Various Years & Models
- Available with 1156 (Single Function) or 1157 (Dual Function) Plug
- Load Resistor (UP Item # 34205) Maybe Required for Proper Installation

Item Number	LEDs	Lens	Plug	Pack
37200 (HOT)	21 Amber	Amber	1156	1 Pc./Card
37201 (HOT)	21 Red	Red	1156	1 Pc./Card
37202 (HOT)	21 Amber	Clear	1156	1 Pc./Card
37203 (HOT)	21 Red	Clear	1156	1 Pc./Card
37574 (HOT)	21 Amber	Amber	1157	1 Pc./Card
37575 (HOT)	21 Red	Red	1157	1 Pc./Card
37576 (HOT)	21 Amber	Clear	1157	1 Pc./Card
37577 (HOT)	21 Red	Clear	1157	1 Pc./Card
37095 (HOT)	21 Amber	Clear	1156	1 Pc./Card
37096 (HOT)	21 Red	Clear	1156	1 Pc./Card
37097 (HOT)	21 Amber	Smoke	1157	1 Pc./Card
37098 (HOT)	21 Red	Smoke	1157	1 Pc./Card



## Chrome Harley Rear Turn Signal Housing

### Description

- Chrome Harley Rear Turn Signal Housing
- Available with 1156 (Single Function) or 1157 (Dual Function) Plug

Item Number	Description	Plug	Pack
30490 (NEW)	Rear Turn Signal Housing	1157	1 Pc./Box
30491 (NEW)	Rear Turn Signal Housing	1156	1 Pc./Box



# WHAT'S NEW | APR 2015

## 33 mm Thread-On "Low Rider" Nut Cover

### Description

- Chrome Plastic 33 mm Thread-On Nut Covers, Available in Various Sizes and Styles
- 33 mm Nut Cover Fits Lug Nuts on Hub Piloted Wheels
- All Nut Cover are Flanged to Cover Up the Flange on the 33 mm Nut

Item Number	Size	Height	Flange	Pack
<b>10719B (NEW)</b>	33 mm	2"	Yes	1 Pc./Bag
<b>10064 (HOT)</b>	33 mm	2 3/4"	Yes	10 Pcs./Pack
<b>10064B (HOT)</b>	33 mm	2 3/4"	Yes	1 Pc./Bag



## Chrome Nut Cover - Steel

### Description

- Chrome Plated Steel Nut Covers
- Available in Bulk or 10 Piece Display Pack

Item Number	Size	Height	Shape	Flange	Pack
<b>10018 (HOT)</b>	3/4"	11/16"	Standard	No	100/Case
<b>10018P (HOT)</b>	3/4"	11/16"	Standard	No	10 Pcs./Pack



## 30" Spring Loaded Mud Flap Hanger w/ Welded End Cap

### Description

- 30" Heavy Duty Spring Loaded Mud Flap Hanger
- Includes Welded End Cap Plug
- 2 1/2" Bolt Pattern

Item Number	Bolt Center	Finish	End Cap	Pack
<b>10712 (NEW)</b>	2 1/2"	Black	Closed	1 Pair/Box

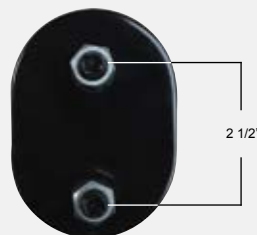

## 30" Spring Loaded Mud Flap Hanger - Reflector

### Description

- 30" Heavy Duty Spring Loaded Mud Flap Hanger with Conspicuity Reflector
- Available in Stainless Steel, Chrome, or Black Painted Finish
- Stainless Steel End Plug Available Separately: Item # 20611

Item Number	Bolt Center	Finish	End Cap	Pack
<b>10660 (HOT)</b>	2 1/2"	304 Stainless	Open	1 Pair/Box
<b>10849 (HOT)</b>	2 1/2"	430 Stainless	Open	1 Pair/Box
<b>10697 (HOT)</b>	2 1/2"	Chrome	Open	1 Pair/Box



# WHAT'S NEW | MAY 2015

## Freightliner Cascadia Light / CB Antenna Bracket

### Description

- Stainless Steel Single Stud Pedestal Light and CB Antenna Bracket for Freightliner Cascadia
- Mount onto Various Freightliner Cascadia Mirror Arms. Simply Remove the Mirror Bracket Mounting Screws, Install the Bracket, and Reinstall the Screws
- Please Specify Driver or Passenger Side

Item Number	Application	Description	Pack
<b>42374 (NEW)</b>	Driver	Light / CB Antenna Bracket	1 Pc./Box
<b>42375 (NEW)</b>	Passenger	Light / CB Antenna Bracket	1 Pc./Box



## 6 High Power LED Dual Color Warning Light

### Description

- 6 High Power LED Super Thin, Dual Color, Directional Warning Light, Only 3/8" Tall
- 12V - 24V Application, Surface Mount, 19 Flash Pattern, Multiple Light Synchronization, Mounting Holes are 4" Apart
- Approximate Size: 4 7/16" L x 1 1/8" W x 3/8" H, **3 Year Warranty**

Item Number	LEDs	Application	Flash Pattern	Pack
<b>36926B (NEW)</b>	3 Amber + 3 White	12V - 24V	19	1 Pc./Box



## 2 High Power LED 1157 Bulb

### Description

- 1157 Bulb with 2 High Power 2 Watt LEDs, Super Bright, 250 Lumens
- Available in Amber, Red, and White
- Double Contact, Offset Pin

Item Number	LEDs	Bulb Type	Package	Pack
<b>36932 (NEW)</b>	2 Amber	1157	Carded	1 Pc./Card
<b>36934 (NEW)</b>	2 Red	1157	Carded	1 Pc./Card
<b>36935 (NEW)</b>	2 White	1157	Carded	1 Pc./Card



**HIGH POWER**  
**2 WATT X 2**  
**LED**

**LIGHT**  
**250**  
**LUMENS**

## 2 High Power LED 1156 Bulb

### Description

- 1156 Bulb with 2 High Power 2 Watt LEDs, Super Bright, 250 Lumens
- Available in Amber, Red, and White
- Single Contact, Straight Pin

Item Number	LEDs	Bulb Type	Package	Pack
<b>36928 (NEW)</b>	2 Amber	1156	Carded	1 Pc./Card
<b>36930 (NEW)</b>	2 Red	1156	Carded	1 Pc./Card
<b>36931 (NEW)</b>	2 White	1156	Carded	1 Pc./Card



**HIGH POWER**  
**2 WATT X 2**  
**LED**

**LIGHT**  
**250**  
**LUMENS**



## 5 LED "M3 Millennium" Marker Light - GLO Light

### Description

- 5 LED "M3 Millennium" Clearance/Marker Light with Chrome Plastic Bezel
- Unique Patented "GLO" Design
- Hard Wired with 2 Wires, **Lifetime Warranty**

Item Number	LEDs	Lens	Package	Pack
<b>36971 (NEW)</b>	5 Red	Clear	Carded	1 Pc./Card
<b>36968 (HOT)</b>	5 Amber	Amber	Carded	1 Pc./Card
<b>36969 (HOT)</b>	5 Red	Red	Carded	1 Pc./Card
<b>36970 (HOT)</b>	5 Amber	Clear	Carded	1 Pc./Card



## Freightliner Cascadia Bumper Reinforcement

### Description

- Bumper End Reinforcement for Freightliner Cascadia
- Available With or Without Tow Hole
- Please Specify Driver or Passenger Side

Item Number	Application	Fog Light Hole	OEM Number
<b>20893 (NEW)</b>	Driver	No	A21-28619-000
<b>20894 (NEW)</b>	Passenger	No	A21-28619-001
<b>20895 (NEW)</b>	Driver	Yes	A21-28619-002
<b>20896 (NEW)</b>	Passenger	Yes	A21-28619-003



## Freightliner Cascadia Bumper End

### Description

- Bumper End for Freightliner Cascadia
- Available with or without Fog Light Hole
- Please Specify Driver or Passenger Side

Item Number	Application	Fog Light Hole	OEM Number
<b>20846 (HOT)</b>	Driver	No	21-27300-008
<b>20847 (HOT)</b>	Passenger	No	21-27300-009
<b>20848 (HOT)</b>	Driver	Yes	21-27300-000
<b>20849 (HOT)</b>	Passenger	Yes	21-27300-001



## Chrome "Moon" Front Axle Cover - 33 mm Thread-On

### Description

- Chrome "Moon" Front Axle Cover with Removable Cap
- Universal Fit, Fits Most 1 1/4" Bolt Circle / Center Applications
- 10 Low Profile 33 mm Thread-On Nut Cover Included: Item # 10719B
- Fits Most 20", 22 1/2", and 24 1/2" Wheel

Item Number	Description	Package	Pack
<b>10727 (NEW)</b>	33 mm Thread-On	Boxed	1 Pc./Box



# WHAT'S NEW | MAY 2015

## Freightliner Century Bumper End Bracket

### Description

- Bumper End Support Bracket for Freightliner Century
- Please Specify Driver or Passenger Side

Item Number	Application	OEM Number	Pack
<b>20937 (NEW)</b>	Driver	A21-27642-002	Bulk = 1 Pc.
<b>20938 (NEW)</b>	Passenger	A21-27642-003	Bulk = 1 Pc.



20938

20937

## 2005+ Freightliner Century Bumper End

### Description

- Bumper End for 2005+ Freightliner Century
- Available with 1 or 2 Light Cut Out, Also Available without Light Cut Out
- Please specify Driver or Passenger Side

Item Number	Application	Light Cut Out	OEM Number
<b>21066 (HOT)</b>	Driver	2	21-26684-004
<b>21067 (HOT)</b>	Passenger	2	21-26684-005
<b>21068 (HOT)</b>	Driver	1	21-26684-002
<b>21069 (HOT)</b>	Passenger	1	21-26684-003
<b>21175 (HOT)</b>	Driver	No	21-26684-000
<b>21176 (HOT)</b>	Passenger	No	21-26684-001



21067

21066



21069

21068



21176

21175

## International 02+ Durastar Bumper - Large Tow Hole

### Description

- 2002 and Newer International Durastar Trucks with Large Tow Hole
- Available in Silver, Chrome or Black Finish
- **Overize Freight Policy**

Item Number	Finish	OEM Number	Pack
<b>21266 (NEW)</b>	Silver	3610935C2	1 Pc./Box
<b>21270 (HOT)</b>	Chrome	3610935C2	1 Pc./Box
<b>21271 (HOT)</b>	Black	3610930C1	1 Pc./Box



21266



21270



21271



## 2008+ Mack Pinnacle & 2000-08 Vision Exterior Door Handle

### Description

- 2008+ Mack Pinnacle & 2000-08 Mack Vision Exterior Door Handle
- Please Specify Driver or Passenger Side

Item Number	Application	OEM Number	Pack
<b>42196B (NEW)</b>	Driver	-	1 Pc./Box
<b>42197B (NEW)</b>	Passenger	PQN001600	1 Pc./Box



42196B



42197B



## Chrome 1 1/2" Nut Cover - Push-On

### Description

- Chrome Plastic 1 1/2" Push-On Nut Covers for Hex Nuts and Bolts

Item Number	Size	Height	Flange	Pack
<b>10748B (NEW)</b>	1 1/2"	2 3/4"	Yes	1 Pc.



## LED "DUO LAMP" Motorcycle Rear Fender Tail Light

### Description

- LED "DUO LAMP" Motorcycle Rear Fender Tail Light
- Black Custom Application Mounting Bracket, Available with or without Blue Dot
- Perfect for Custom Motorcycles

Item Number	Description	Housing	Pack
<b>20345 (NEW)</b>	LED "DUO LAMP" w/Blue Dot	Black	1 Pc./Box
<b>20290 (NEW)</b>	LED "DUO LAMP"	Black	1 Pc./Box



## United Pacific Logo Mud Flap

### Description

- Black Rubber Mud Flap with United Pacific Logo
- Available in 24", 30", and 36" Long

Item Number	Description	Package	Pack
<b>10587 (NEW)</b>	24" x 24" UP Logo Mud Flap	Bulk	1 Pc.
<b>10588 (NEW)</b>	24" x 30" UP Logo Mud Flap	Bulk	1 Pc.
<b>10589 (NEW)</b>	24" x 36" UP Logo Mud Flap	Bulk	1 Pc.



## LED Motorcycle Rear Fender Tail Light - with Blue Dot 1940-53 Chevy Truck Style

### Description

- LED Motorcycle Rear Fender Tail Light with LED License Light
- Chrome Custom Application Mounting Bracket
- Blue Dot with Chrome Plated Ring Looks Exactly As Original
- Blue Dot Can Be Controlled Independently with Additional Wiring

Item Number	Description	Housing	Pack
<b>20659 (NEW)</b>	LED Tail Light w/Blue Dot	Chrome	1 Pc./Box



# WHAT'S NEW | JUN 2015

## 18 LED 4" Round "GLO" Light

### Description

- 18 Red LED 4" S/T/T & P/T/C "GLO" Light
- Unique Patent "GLO" Design, Halo Effect on Running, All LEDs Lit on Stop
- 3 Contact Female Terminal
- Recommended Plug: Item # 34212/34216, [Lifetime Warranty](#)

Item Number	LEDs	Lens	Package	Pack
<b>36922 (NEW)</b>	18 Red	Red	Carded	1 Pc./Card



**On Running**  
LED Halo Effect Only

**On Stop**  
All LEDs Lit



**GloLight™**  
Stand Out

## 22 LED 6" Oval "GLO" Light

### Description

- 22 Red LED 6" S/T/T & P/T/C "GLO" Light
- Unique Patent "GLO" Design, Halo Effect on Running, All LEDs Lit on Stop
- 3 Contact Female Terminal
- Recommended Plug: Item # 34212/34216, [Lifetime Warranty](#)

Item Number	LEDs	Lens	Package	Pack
<b>36924 (NEW)</b>	22 Red	Red	Carded	1 Pc./Card



**On Running**  
LED Halo Effect Only

**On Stop**  
All LEDs Lit



**GloLight™**  
Stand Out

## 21 LED 05+ Freightliner Century Signal Light - GLO Light

### Description

- Fits 2005 & Newer Freightliner Century Models
- 21 Amber LED (9 High Power LED and 12 SMD LED)
- Unique Patented "GLO" Design, [Lifetime Warranty](#)

Item Number	LEDs	Lens	Package	Pack
<b>37115 (NEW)</b>	21 Amber	Clear	Carded	1 Pc./Card



**On Running**  
LED Halo Effect Only

**On Stop**  
All LEDs Lit



## 8 Watt High Power H8/H11/H16 LED Bulb

### Description

- High Power H8/H11/H16 LED Bulb
- 8 Watt Cree LED, Cree LEDs Are Made in USA
- 500 Lumens / 6000K Brightness, 12 V Application
- **Fan Less Design**, Proprietary Integrated Heat Sink Design Dissipates Heat without Use of External Cooling Fan
- Includes In-Line Ballast

Item Number	LEDs	Bulb Type	Package	Pack
<b>36927 (NEW)</b>	1 White	H8/H11/H16	Carded	1 Pc./Card

**CREE**  
LEDs

**Fan Less Design**



# WHAT'S NEW | JUN 2015

## 24 LED Rectangular Dual Headlight Bezel w/ Visor - GLO Light

### Description

- 24 LED Chrome Plastic Rectangular Dual Headlight Bezel with Visor
- Unique Patented "GLO" Design
- Available with Amber (UP Item # 36861B) or Clear (UP Item # 36863B) Lens LED Light Bar
- Chrome Plastic Headlight Bezel Available Separately: Item # 32350B
- US Patent: D571,500 Canadian Industrial Design Registration: 123372, Mexico Design Patent: 27174

Item Number	LEDs	Lens	Light	Pack
<b>32700 (NEW)</b>	24 Amber	Amber	36861B	1 Pc./Card
<b>32701 (NEW)</b>	24 Amber	Clear	36863B	1 Pc./Card



## 24 LED Freightliner FLD Headlight Bezel - GLO Light

### Description

- 24 Amber LED Chrome Plastic Headlight Bezel for Freightliner FLD
- Unique Patented "GLO" Design
- Available with Amber (UP Item # 36861B) or Clear (UP Item # 36863B) Lens LED Light Bar
- Fits Freightliner FLDs with 2 Piece Clip-On Turn Signal Headlight Bezel
- Please Specify Driver or Passenger Side

Item Number	Application	LEDs	Lens	Pack
<b>32702 (NEW)</b>	Driver	Amber	Amber	1 Pc./Box
<b>32703 (NEW)</b>	Passenger	Amber	Amber	1 Pc./Box
<b>32704 (NEW)</b>	Driver	Amber <td Clear	1 Pc./Box	
<b>32705 (NEW)</b>	Passenger	Amber	Clear	1 Pc./Box

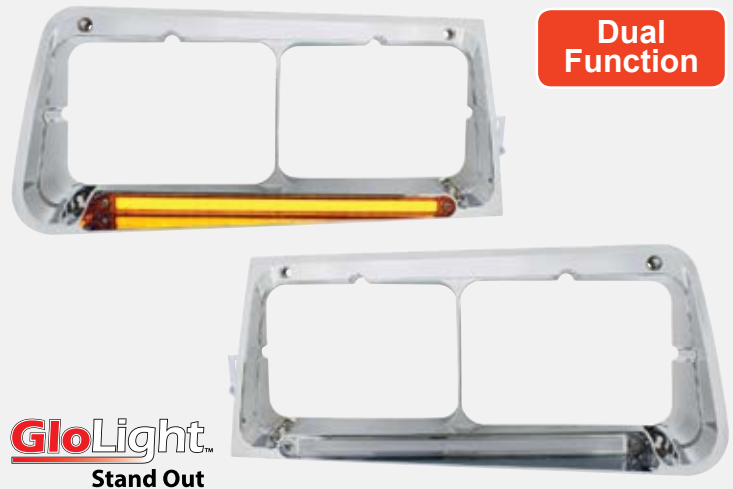

## 24 LED 12" Dual Function Light Bar - GLO Light

### Description

- 24 LED 12" Dual Function Light Bar, Unique Patented "GLO" Design
- Available with Amber or Red LEDs in Colored or Clear Lens
- Approximate Size: 12" L x 5/8" W, Mounting Holes Approximately 11 7/16" Apart, **Lifetime Warranty**

Item Number	LEDs	Lens	Package	Pack
<b>36861B (NEW)</b>	24 Amber	Amber	Bulk	1 Pc.
<b>36862B (NEW)</b>	24 Red	Red	Bulk	1 Pc.
<b>36863B (NEW)</b>	24 Amber	Clear	Bulk	1 Pc.
<b>36864B (NEW)</b>	24 Red	Clear	Bulk	1 Pc.



## 24 LED 12" Light Bar with Chrome Housing - GLO Light

### Description

- 24 LED 12" Light Bar with Chrome Plastic Bezel, Unique Patented "GLO" Design
- Available with Amber (UP Item # 36861B), Red (UP Item # 36862B) Lens or Amber LED (UP Item # 36863B), Red (UP Item # 36864B) Clear Lens
- 12" Chrome Plastic Light Bar Bezel Available Separately: Item # 30933B
- Mounting Screws Can Be Moved to Accommodate Mounting Distance from 4 1/2" - 7 3/8" Apart

Item Number	LEDs	Lens	Light	Pack
<b>32706 (NEW)</b>	24 Amber	Amber	36861B	1 Pc./Card
<b>32707 (NEW)</b>	24 Red	Red	36862B	1 Pc./Card
<b>32708 (NEW)</b>	24 Amber	Clear	36863B	1 Pc./Card
<b>32709 (NEW)</b>	24 Red	Clear	36864B	1 Pc./Card





# WHAT'S NEW | JUN 2015

## Chrome Kenworth Hood Emblem Light - 12" GLO Light

### Description

- Chrome Plastic Kenworth Hood Emblem Light Bezel with 12" LED GLO Light
- Unique Patented "GLO" Design
- Available with Amber or Red LEDs in Colored or Clear Lens
- Chrome Plastic Hood Emblem Housing Available Separately: Item # 39878-1
- \*Patent Pending\*

Item Number	LEDs	Lens	Light	Pack
<b>32710 (NEW)</b>	24 Amber	Amber	36861B	1 Pc./Card
<b>32711 (NEW)</b>	24 Red	Red	36862B	1 Pc./Card
<b>32712 (NEW)</b>	24 Amber	Clear	36863B	1 Pc./Card
<b>32713 (NEW)</b>	24 Red	Clear	36864B	1 Pc./Card



**Dual Function**

**GloLight™**  
Stand Out



Kenworth is a registered trademark, the use of the registered trademark is solely for demonstration purposes and does not constitute affiliation with or endorsement by Kenworth, Paccar, or its associates.

## 48 LED 24" Light Bar - GLO Light

### Description

- 48 LED Dual 12" Light Bar with Plastic Bezel
- Unique Patented "GLO" Design
- Available with Amber or Red LEDs in Colored or Clear Lens
- Unique Chrome Bezel Design Allows Two 12" LED Light Bars to be Assembled into One 24" Long LED Light Bar
- Chrome Plastic Dual Light Bar Bezel Available Separately: Item # 30886B
- Stainless Steel Mounting Screws Can Be Moved to Accommodate Mounting Distance from 4 1/2" - 7 3/8" Apart

Item Number	LEDs	Lens	Light	Pack
<b>32714 (NEW)</b>	24 Amber/ 24 Amber	Amber/ Amber	36861B/ 36861B	1 Pc./Card
<b>32715 (NEW)</b>	24 Red/ 24 Red	Red/ Red	36862B/ 36862B	1 Pc./Card
<b>32716 (NEW)</b>	24 Amber/ 24 Amber	Clear/ Clear	36863B/ 36863B	1 Pc./Card
<b>32717 (NEW)</b>	24 Red/ 24 Red	Clear/ Clear	36864B/ 36864B	1 Pc./Card

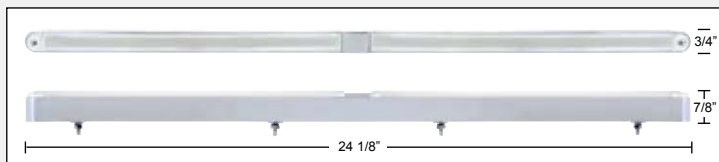

**Dual Function**

**GloLight™**  
Stand Out

## Chrome Volvo VNL Exterior Door Handle

### Description

- Chrome Exterior Door Handle for Volvo VNL
- Please Specify Driver or Passenger Side

Item Number	Application	OEM Number	Pack
<b>41692 (NEW)</b>	Driver	20398466	1 Pc./Box
<b>41693 (NEW)</b>	Passenger	20398467	1 Pc./Box



## 2002+ International Durastar Exterior Door Handle

### Description

- Exterior Door Handle for 2002+ International Durastar
- Please Specify Driver or Passenger Side

Item Number	Application	OEM Number	Pack
<b>42212B (NEW)</b>	Driver	2587515C1L	1 Pc.
<b>42213B (NEW)</b>	Passenger	2587515C1R	1 Pc.

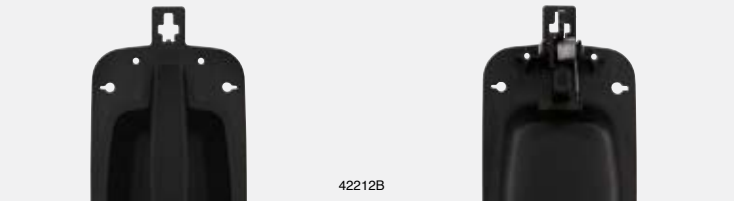

# WHAT'S NEW | JUN 2015

## United Pacific LED "GLO" Light Display - Version 2

### Description

- United Pacific LED "GLO" Light Display
- Multi Functional Control Allows Drivers to See the Lights in Different Modes of Operations

Item Number	Description	Package	Pack
99079 (NEW)	LED "GLO" Light Display	Boxed	1 Pc./Box



**GloLight™**  
Stand Out

## Motorcycle Rear Turn Signal Bar with 12" LED Light Bar - GLO Light

### Description

- Motorcycle Rear Turn Signal Bar with 12" LED Light Bar
- Unique Patented "GLO" Design
- Available with Red LEDs in Colored or Clear Lens
- Motorcycle Rear Turn Signal Bar with Light Cutout Available Separately: Item # 71000

Item Number	LEDs	Lens	Light	Pack
71006 (NEW)	24 Red	Red	36862B	1 Pc./Box
71007 (NEW)	24 Red	Clear	36864B	1 Pc./Box



Dual  
Function

**GloLight™**  
Stand Out

## "DUO LAMP" Motorcycle Rear Fender Tail Light

### Description

- Incandescent "DUO LAMP" Motorcycle Rear Fender Tail Light
- Black Custom Application Mounting Bracket, Available with or without Blue Dot
- Perfect for Custom Motorcycles

Item Number	Description	Blue Dot	Pack
20292 (NEW)	Red Glass Lens	No	1 Pc./Box
20291 (NEW)	Red Glass Lens w/ Blue Dot	Yes	1 Pc./Box
20293 (NEW)	Glass Lens w/ "STOP" Lettering	No	1 Pc./Box



20293



20292



Incandescent License Light



### 7 LED Freightliner Turn Signal Light

#### Description

- 7 LED Turn Signal Light for Freightliner
- Fits Freightliner Cascadia and Various Freightliner Models
- Available in Amber or Clear Lens
- OEM Plug, **Lifetime Warranty**

Item Number	LEDs	Lens	OEM Number	Pack
<b>37077 (NEW)</b>	7 Amber	Amber	A06-58770-000	1 Pc./Card
<b>37078 (NEW)</b>	7 Amber	Clear	A06-58770-000	1 Pc./Card



### 24 LED Rectangular Cab Light Assembly - GLO Light

#### Description

- 24 Amber LED Cab Light with Chrome Plastic Housing
- OEM Fit, Fits Original OEM Mounting Holes
- Unique Patented "GLO" Design

Item Number	LEDs	Lens	Package	Pack
<b>36677 (NEW)</b>	24 Amber	Amber	Carded	1 Pc./Card
<b>36678 (NEW)</b>	24 Amber	Clear	Carded	1 Pc./Card

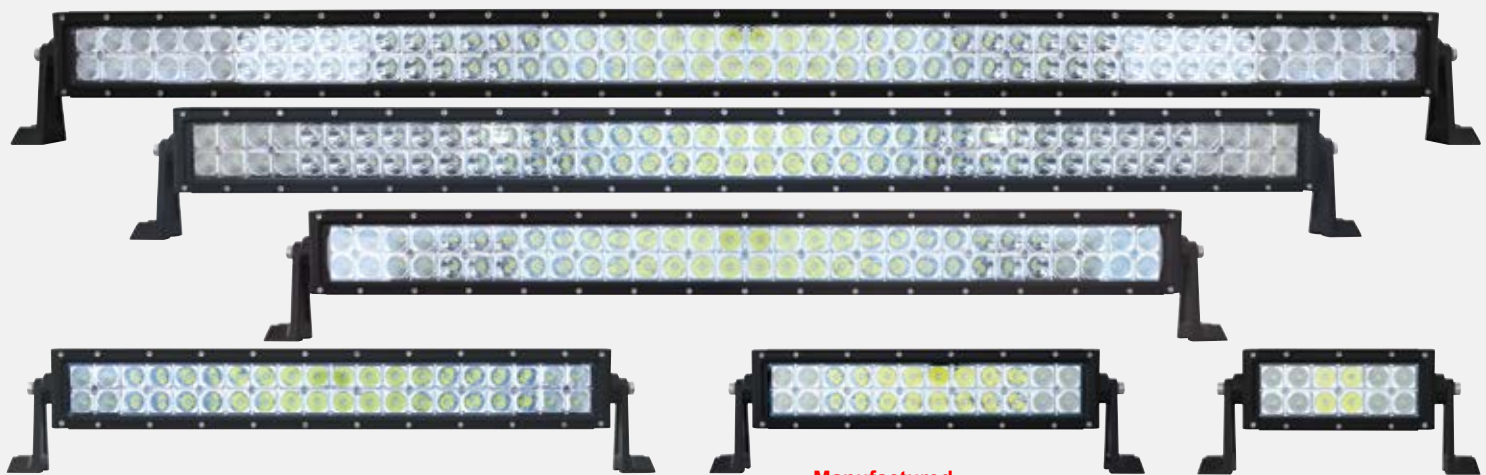

### High Power LED Double Row Light Bar

#### Description

- 3W High Power "Cree" LED, Double Row LED Light Bar
- 12V - 24V Application
- Manufactured with USA Made "Cree" LEDs
- 3 1/8" Tall x 3 1/2" Wide, Light is 4 3/4" Tall with Mounting Bracket
- Available in 6 Different Lengths, Heavy Duty Aluminum Housing

Item Number	LEDs	Lumens	Length	Pack
<b>36781 (NEW)</b>	12	2640 lm	7 1/2"	1 Pc./Box
<b>36782 (NEW)</b>	24	5280 lm	13 1/2"	1 Pc./Box
<b>36783 (NEW)</b>	40	8800 lm	21 1/2"	1 Pc./Box
<b>36784 (NEW)</b>	60	13200 lm	31 1/2"	1 Pc./Box
<b>36785 (NEW)</b>	80	17600 lm	41 1/2"	1 Pc./Box
<b>36786 (NEW)</b>	96	21120 lm	50 1/2"	1 Pc./Box

Manufactured with USA Made  
**CREE** LEDs



**MULTIPLE 12V - 24V VOLTAGE**

**IP 67 Rated**



# WHAT'S NEW | JUL 2015

## 18 LED 4" Round "GLO" Light

### Description

- 18 LED 4" S/T/T & P/T/C "GLO" Light
- Unique Patented "GLO" Design, Halo Effect on Running, All LEDs Lit on Stop
- 3 Contact Female Terminal
- Recommended Plug: Item # 34212/34216, [Lifetime Warranty](#)

Item Number	LEDs	Lens	Package	Pack
<b>36923 (NEW)</b>	18 Amber	Amber	Carded	1 Pc./Card
<b>36922 (HOT)</b>	18 Red	Red	Carded	1 Pc./Card



**On Running**  
LED Halo Effect Only

**On Stop**  
All LEDs Lit



**GloLight™**  
Stand Out

## 22 LED 6" Oval "GLO" Light

### Description

- 22 LED 6" S/T/T & P/T/C "GLO" Light
- Unique Patented "GLO" Design, Halo Effect on Running, All LEDs Lit on Stop
- 3 Contact Female Terminal
- Recommended Plug: Item # 34212/34216, [Lifetime Warranty](#)

Item Number	LEDs	Lens	Package	Pack
<b>36925 (NEW)</b>	22 Amber	Amber	Carded	1 Pc./Card
<b>36924 (HOT)</b>	22 Red	Red	Carded	1 Pc./Card



**On Running**  
LED Halo Effect Only

**On Stop**  
All LEDs Lit



**GloLight™**  
Stand Out

## 20 LED 4" Back-Up Light - Competition Series

### Description

- 4" Back-Up Light with 20 Super White LED
- Epoxy Sealed, Specially Designed Lens, 3 Contact Female Terminal
- Recommended Plug: Item # 34212/34216, [Lifetime Warranty](#)

Item Number	LEDs	Lens	Package	Pack
<b>36680 (NEW)</b>	20 White	Clear	Carded	1 Pc./Card



**COMPETITION**  
SERIES

## 20 LED 6" Oval Back-Up Light - Competition Series

### Description

- 6" Oval Back-Up Light with 20 Super White LED
- Epoxy Sealed, Specially Designed Lens, 3 Contact Female Terminal
- Recommended Plug: Item # 34212/34216, [Lifetime Warranty](#)

Item Number	LEDs	Lens	Package	Pack
<b>36679 (NEW)</b>	20 White	Clear	Carded	1 Pc./Card



**COMPETITION**  
SERIES

# WHAT'S NEW | JUL 2015

## 7 LED 6" Oval S/T/T Light

### Description

- 6" Oval S/T/T Light with 7 Red LED
- Available in Red or Clear Lens, 3 Contact Female Terminal
- Recommended Plug: Item # 34212/34216, **Lifetime Warranty**

Item Number	LEDs	Lens	Package	Pack
<b>36855 (NEW)</b>	7 Red	Red	Carded	1 Pc./Card
<b>36857 (NEW)</b>	7 Red	Clear	Carded	1 Pc./Card



## 3 LED Dual Function Mini Diamond Light

### Description

- 3 LED Dual Function Mini Auxiliary/Utility Light, Unique Faceted Diamond Lens
- Requires a 3/4" Opening
- Mounts with Enclosed Rubber Grommet
- 3 Wire Hardwired
- Stainless Steel Bezel Available Separately: Item # 20527B

Item Number	LEDs	Lens	Package	Pack
<b>36869 (NEW)</b>	3 Amber	Amber	Carded	1 Pc./Card
<b>36870 (NEW)</b>	3 Blue	Blue	Carded	1 Pc./Card
<b>36871 (NEW)</b>	3 Red	Red	Carded	1 Pc./Card
<b>36872 (NEW)</b>	3 White	Clear	Carded	1 Pc./Card

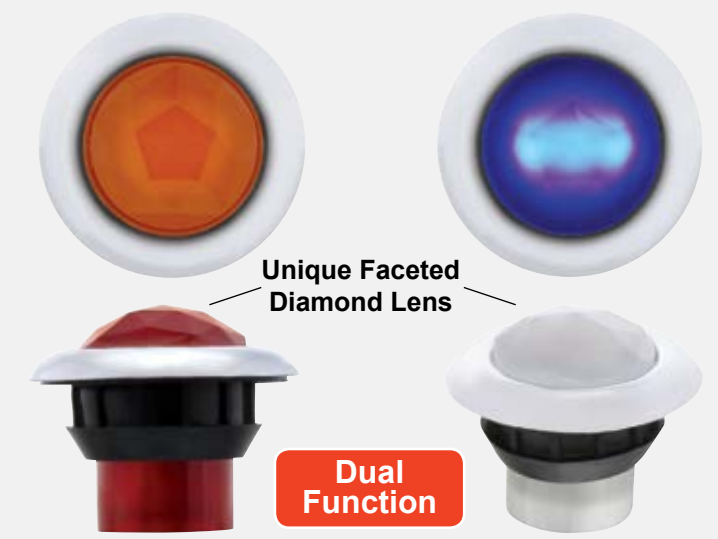

## 3 High Power LED Mini Warning Light

### Description

- 3 High Power LED Mini Warning Light with Chrome Bezel
- 12V/24V Application, 12 Flash Pattern
- 3 Wire Hardwired, Dual Function
- Available in Amber or Clear Lens

Item Number	LEDs	Lens	Package	Pack
<b>36681B (NEW)</b>	3 Amber	Clear	Bulk	1 Pc.
<b>36682B (NEW)</b>	3 White	Clear	Bulk	1 Pc.

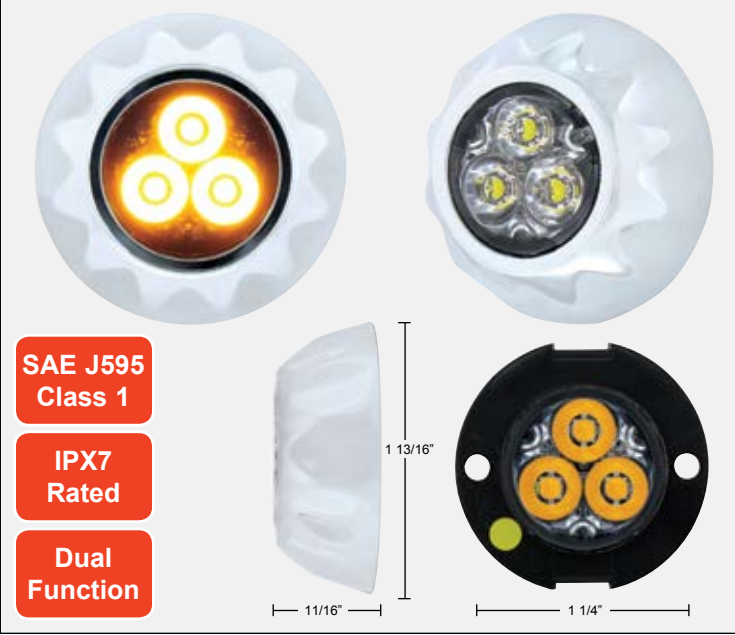

**SAE J595  
Class 1**

**IPX7  
Rated**

**Dual  
Function**

## LED Flasher Warning Module

### Description

- Converts Regular LED Lights Into Flashing Warning Lights
- 24 Selectable Flash Patterns, Sync or Alternating Flash
- 12V Application, 2 Outputs, 20 AMP Max Draw
- 1 Module Works with 2 LED Lights

Item Number	Description	Package	Pack
<b>90660 (NEW)</b>	LED Warning Module	Carded	1 Pc./Card



**24 Selectable Flash Patterns Sync or Alternating Flash**



# WHAT'S NEW | JUL 2015

## 48 LED Dual 12" Light Bar - GLO Light

### Description

- 48 LED Dual 12" Light Bar with Chrome Housing, Unique Patented "GLO" Design
- Available with Amber Lens (UP Item # 36861B), Red Lens (UP Item # 36862B) or Amber LED (UP Item # 36863B), Red LED (UP Item # 36864B) with Clear Lens
- Stainless Steel Mounting Hardware Included
- Chrome Plastic Dual Light Bar Housing Available Separately: Item # 30934B
- Mounting Screws Can Be Moved to Accommodate Mounting Distance from 4 1/2" - 7 3/8" Apart

Item Number	LEDs	Lens	Light	Pack
<b>32718 (NEW)</b>	24 Amber/ 24 Amber	Amber/ Amber	36861B/ 36861B	1 Pc./Card
<b>32719 (NEW)</b>	24 Red/ 24 Red	Red/ Red	36862B/ 36862B	1 Pc./Card
<b>32720 (NEW)</b>	24 Amber/ 24 Amber	Clear/ Clear	36863B/ 36863B	1 Pc./Card
<b>32721 (NEW)</b>	24 Red/ 24 Red	Clear/ Clear	36864B/ 36864B	1 Pc./Card

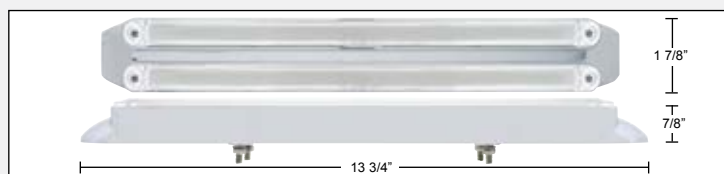

**Dual Function**  
**GloLight**  
Stand Out

## 24 LED 2005+ Freightliner Mirror Light Bar - GLO Light

### Description

- Chrome Plastic Mirror Light Bar Housing with 12" LED Light Bar for 2005+ Freightliner Mirror Cover
- Unique Patented "GLO" Design
- Chrome Plastic Mirror Light Bar Housing Available Separately: Item # 42069B
- Only Fit UP Item # 42060, 42061B, and 42062B

Item Number	LEDs	Lens	Light	Pack
<b>32722 (NEW)</b>	24 Amber	Amber	36861B	1 Pc.
<b>32723 (NEW)</b>	24 Amber	Clear	36863B	1 Pc.

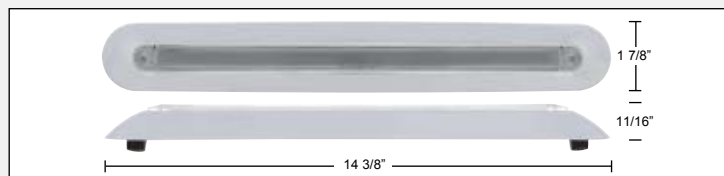

**Dual Function**  
**GloLight**  
Stand Out

## LED Freightliner Mirror Cover - GLO Light

### Description

- Chrome Plastic Mirror Cover with 12" LED GLO Light Bar for 2005+ Freightliner Century and Columbia Trucks
- Unique Patented "GLO" Design
- Available with Amber LED (UP Item # 36861B) or Amber LED with Clear Lens (UP Item # 36863B)
- Chrome Plastic Light Bar Mirror Cover Available Separately: Item # 42073 - Driver / Item # 42077 - Passenger
- Mounts Directly onto the Mirror Bracket/Post. The Mounting Holes for Screws Are 12-1/2" Apart
- Sold Separately, Please Specify Driver or Passenger Side

Item Number	Application	LEDs	Lens	Pack
<b>42398 (NEW)</b>	Driver	Amber	Amber	1 Pc./Box
<b>42399 (NEW)</b>	Passenger	Amber	Amber	1 Pc./Box
<b>42400 (NEW)</b>	Driver	Amber	Clear	1 Pc./Box
<b>42401 (NEW)</b>	Passenger	Amber	Clear	1 Pc./Box



**Dual Function**

**GloLight**  
Stand Out





## High Power LED Directional / Warning Light Bars

### Description

- High Power LED Directional / Warning Light Bars
- Super Slim Profile, Only 7/8" Tall x 1 1/2" Wide, Available in 4 Different Length
- 20 Warning Patterns and 11 Arrow Patterns
- Brackets Required for Installation, Mounting Brackets Sold Separately: Item # 36941B Surface Mount Bracket or 36942B L Bracket
- 4 Wire Hardwired, Heavy Duty Aluminum Housing

Item Number	Light Head	LEDs	Length	Pack
<b>36943 (HOT)</b>	4	12 Amber	18"	1 Pc./Box
<b>36944 (HOT)</b>	6	18 Amber	26 1/2"	1 Pc./Box
<b>36945 (HOT)</b>	8	24 Amber	35"	1 Pc./Box
<b>36946 (HOT)</b>	10	30 Amber	43 1/2"	1 Pc./Box

**SAE J595  
Class 13**

**IPX7  
Rated**

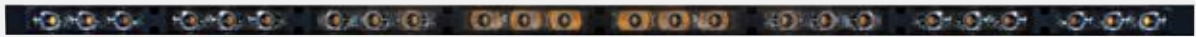
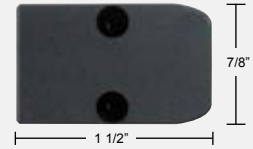

## Traffic Arrow Switch

### Description

- Traffic Arrow Switch for United Pacific Directional / Warning Light Bar
- Allow User to Select Desired Warning Pattern and Flash Direction
- Available with or without LED Indicators

Item Number	Description	Package	Pack
<b>40089 (NEW)</b>	With LED Indicators	Boxed	1 Pc./Box
<b>40090 (NEW)</b>	Without LED Indicators	Boxed	1 Pc./Box



## Mounting Bracket for LED Light Bars

### Description

- Mounting Bracket for LED Light Bars

Item Number	Description	Package	Pack
<b>36941B (HOT)</b>	Surface Mount Bracket	Bulk	1 Pc.
<b>36942B (HOT)</b>	L Bracket	Bulk	1 Pc.



36941B



36942B

## Stainless 2008+ Freightliner Cascadia Bug Deflector

### Description

- Stainless Steel Bug Deflector for 2008+ Freightliner Cascadia Trucks
- Drilling of Mounting Holes through Hood Required, 430 Stainless
- Mounts Behind Grill Bezel, Installation Hardware Included

Item Number	Fits	Package	Pack
29090 (NEW)	2008+ Freightliner Cascadia	Boxed	1 Pc./Box



430  
Stainless



## Stainless Freightliner Columbia Bug Deflector

### Description

- Stainless Steel Bug Deflector for Freightliner Columbia Trucks
- Drilling of Mounting Holes through Hood Required, 430 Stainless
- Mounts Behind Grill Bezel, Installation Hardware Included

Item Number	Fits	Package	Pack
29092 (NEW)	Freightliner Columbia	Boxed	1 Pc./Box



430  
Stainless



## Stainless 2005+ Freightliner Century Bug Deflector

### Description

- Stainless Steel Bug Deflector for 2005+ Freightliner Century Trucks
- Drilling of Mounting Holes through Hood Required, 430 Stainless
- Mounts Behind Grill Bezel, Installation Hardware Included

Item Number	Fits	Package	Pack
29091 (NEW)	2005+ Freightliner Century	Boxed	1 Pc./Box



430  
Stainless



## Stainless Freightliner FLD 120/112 Bug Deflector

### Description

- Stainless Steel Bug Deflector for Freightliner FLD 120/112 Trucks
- Drilling of Mounting Holes through Hood Required, 430 Stainless
- Mounts Behind Grill Bezel, Installation Hardware Included

Item Number	Fits	Package	Pack
29093 (NEW)	Freightliner FLD 120/112	Boxed	1 Pc./Box



430  
Stainless





# WHAT'S NEW | JUL 2015

## Stainless Freightliner Classic/Classic XL Bug Deflector

### Description

- Stainless Steel Bug Deflector for Freightliner Classic/Classic XL Trucks
- Drilling of Mounting Holes through Hood Required, 430 Stainless
- Mounts Behind Grill Bezel, Installation Hardware Included

Item Number	Fits	Package	Pack
<b>29094 (NEW)</b>	Freightliner Classic/Classic XL	Boxed	1 Pc./Box



## Freightliner Cascadia Mirror Cover

### Description

- Mirror Cover for Freightliner Cascadia
- Available in Chrome or Black Finish
- Sold Individually, Please Specify Driver or Passenger Side

Item Number	Finish	Application	OEM Number	Pack
<b>42396 (NEW)</b>	Black	Driver	TL28715	1 Pc./Box
<b>42397 (NEW)</b>	Black	Passenger	TL28714	1 Pc./Box
<b>42355 (HOT)</b>	Chrome	Driver	TL28713	1 Pc./Box
<b>42356 (HOT)</b>	Chrome	Passenger	TL28712	1 Pc./Box



42356



42396



## 30" Spring Loaded Mud Flap Hanger - Competition Series

### Description

- 30" Heavy Duty Spring Loaded Mud Flap Hanger, Competition Series
- Available in 430 Stainless Steel, Chrome, or Black Painted Finish
- Stainless Steel End Plug Available Separately: Item # 20611

Item Number	Bolt Center	Finish	End Cap	Pack
<b>11300 (NEW)</b>	2 1/2"	Chrome	End	1 Pair/Box
<b>11310 (NEW)</b>	2 1/2"	Stainless	End	1 Pair/Box
<b>11320 (NEW)</b>	2 1/2"	Black	End	1 Pair/Box



## Kenworth Window Crank

### Description

- Chrome Kenworth Window Crank, Fits Various Kenworth Models and Years
- OEM Part Number: 20-16677

Item Number	OEM Part Number	Package	Pack
<b>41544 (NEW)</b>	20-16677	Carded	1 Pc./Card



## Chrome 33mm Push-On Spike Nut Cover

### Description

- Chrome Plastic Push-On Spike Nut Cover
- Fits 33mm Across Nut without Flange

Item Number	Size	Height	Flange	Pack
10769 (NEW)	33mm	3 1/8"	No	10/Pack



New Retail Card Packaging

## King Pin Lock

### Description

- Heavy Duty Fifth Wheel Lock for Standard Fixed King Pin
- Trailer Theft Deterrent Device
- Keyed Different

Item Number	Description	Package	Pack
90100 (NEW)	King Pin Lock	Boxed	1 Pc./Box



## Aluminum Glad-Hand Extension Handles

### Description

- Aluminum Glad-Hand Extension Handles
- Includes 1 Blue and 1 Red Handle

Item Number	Description	Package	Pack
90626 (NEW)	Extension Handles	Carded	2 Pcs./Card

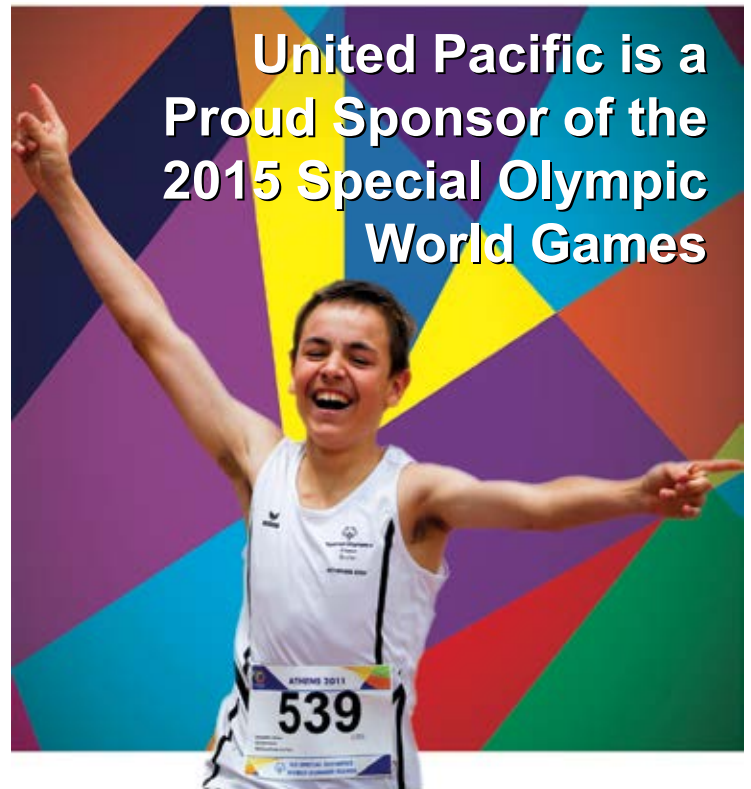

United Pacific is a Proud Sponsor of the 2015 Special Olympic World Games

# WHAT'S NEW | AUG 2015

## 6 High Power LED Super Thin Warning Light

### Description

- 6 High Power LED Super Thin Warning Light, Only 1/4" Tall
- 12V - 24V Application, 23 Flash Pattern
- 3 Wire Hardwired
- Surface Mount, Mounting Holes are 4 3/4" Apart
- Approximate Size: 5 1/8" L x 1 3/16" W x 1/4" H, **Lifetime Warranty**

Item Number	LEDs	Application	Flash Pattern	Pack
<b>36683B (NEW)</b>	6 Amber	Clear	Bulk	1 Pc.
<b>36684B (NEW)</b>	6 White	Clear	Bulk	1 Pc.

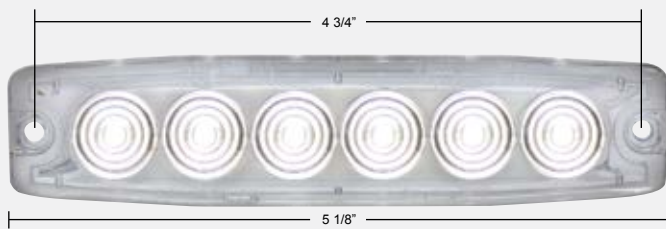

## 8 LED 2 1/2" Clearance / Marker Light - Reflectorized Lens

### Description

- 8 LED 2 1/2" Clearance / Marker Light with Reflectorized Lens
- Kit Includes 2 1/2" Lamp, Rubber Grommet (Item # 31503) and Plug (Item # 34210)
- **Lifetime Warranty**

### 2 1/2" LED LIGHT ONLY

Item Number	LEDs	Lens	Package	Pack
<b>38455B (NEW)</b>	8 Amber	Amber	Bulk	1 Pc.
<b>38456B (NEW)</b>	8 Red	Red	Bulk	1 Pc.

### 2 1/2" LED LIGHT KIT

Item Number	LEDs	Lens	Package	Pack
<b>38455BAK (NEW)</b>	8 Amber	Amber	Bulk	1 Kit
<b>38456BRK (NEW)</b>	8 Red	Red	Bulk	1 Kit



36668 - 8 LED Lighthead



36669 - 12 LED Lighthead



36670 - 16 LED Lighthead

## 49" High Power LED Warning Light Bar

### Description

- 49" High Power LED Warning Light Bar, 12V - 24V Application, 26 Flash Pattern
- 3 LED Fresnel Optics for Front / Rear Lighthead and 6 LED Large D-Fuser for Corner Lighthead
- SAE J845, Class 13, IPX 4 Rated
- Available with 8 (4 Inboards) Lighthead, 12 (8 Inboards) Lighthead, or 16 (12 Inboards) Lighthead
- Brackets Required for Installation, Includes Standard Bolt / Strap Mount Bracket

Item Number	Length	LEDs	LED Heads	Pack
<b>36668 (NEW)</b>	49"	36	8	1 Pc./Box
<b>36669 (NEW)</b>	49"	48	12	1 Pc./Box
<b>36670 (NEW)</b>	49"	60	16	1 Pc./Box

**SAE J845  
Class 13**

**IPX 4  
Rated**



Standard Bolt / Strap Mount



## 6 LED Fender Mount Clearance / Marker Light

### Description

- 6 LED Fender Mount Clearance / Marker Light
- Dual Color Lens with 3 Amber and 3 Red LEDs
- Kit Includes LED Light and Mounting Bracket (Item # 33006), **Lifetime Warranty**

### LED LIGHT ONLY

Item Number	LEDs	Lens	Package	Pack
<b>36774B (NEW)</b>	6	Amber / Red	Bulk	1 Pc.

### LED LIGHT KIT

Item Number	LEDs	Lens	Package	Pack
<b>36774BARK-B (NEW)</b>	6	Amber / Red	Bulk	1 Kit

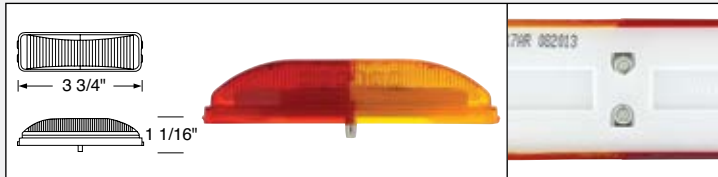

## 2008+ Freightliner Cascadia Center Bumper Inner Reinforcement

### Description

- Center Bumper Inner Reinforcement for 2008+ Freightliner Cascadia
- Available with or without Tow Hole
- **Item Subject to Oversize Freight Policy**

Item Number	OEM Part Number	Tow Hole	Pack
<b>20842 (NEW)</b>	21-28443-000	No	1 Pc./Box
<b>20843 (NEW)</b>	21-28443-004	Yes	1 Pc./Box



20842 - Bumper Reinforcement without Tow Hole



20843 - Bumper Reinforcement with Tow Hole

## 3 LED 14 1/4" ID Light Bar

### Description

- 3 LED 14 1/4" ID Light Bar
- 2 Wire Hardwired
- Mounting Holes are 8 1/2" Apart, **Lifetime Warranty**

Item Number	LEDs	Lens	Package	Pack
<b>38479B (NEW)</b>	3 Red	Red	Bulk	1 Pc.

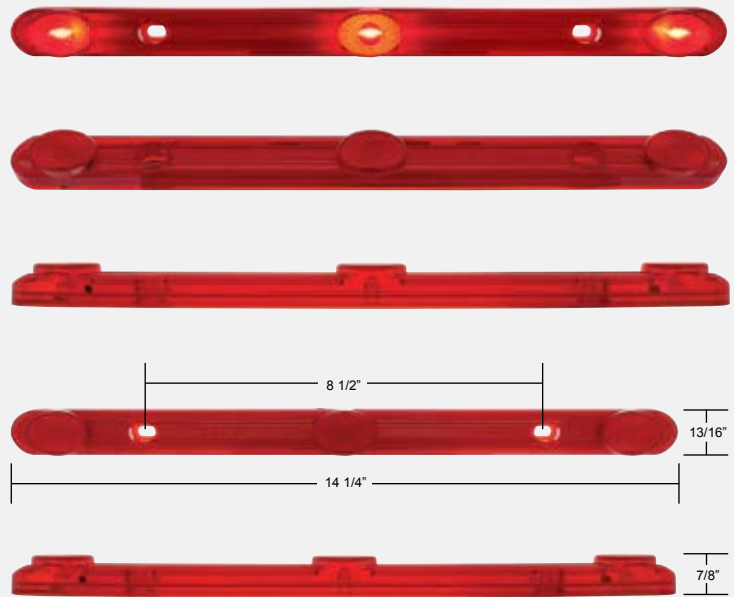

## 2003+ Volvo VNL Grill Screw Set

### Description

- Grill Screw Set for 2003+ Volvo VNL
- 10 Complete Sets of Mounting Hardware

Item Number	Description	Package	Pack
<b>21039B (NEW)</b>	03+ Volvo VNL Screw Set	Bag	1 Set/Bag

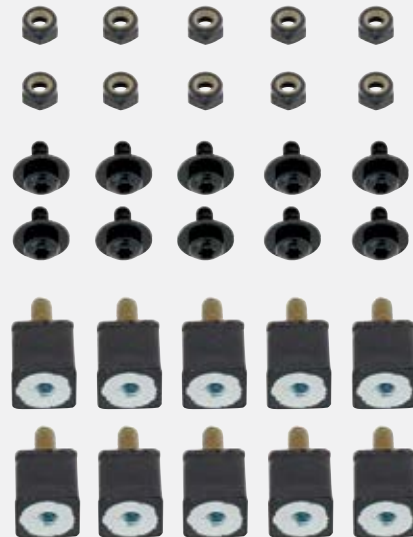

## Freightliner Cascadia Chrome Mirror Assembly

### Description

- Chrome Mirror Assembly for Freightliner Cascadia
- Includes Complete Mirror and Mounting Arm
- Electric Operation with Heat, Chrome Mirror Cover
- Sold Individually, Please Specify Driver or Passenger Side

Item Number	OEM Part Number	Application	Pack
<b>42394 (NEW)</b>	A22-60713-005	Driver	1 Pc./Box
<b>42395 (NEW)</b>	A22-60713-003	Passenger	1 Pc./Box



## Freightliner Cascadia Black Mirror Assembly

### Description

- Black Mirror Assembly for Freightliner Cascadia
- Includes Complete Mirror and Mounting Arm
- Electric Operation with Heat, Black Mirror Cover
- Sold Individually, Please Specify Driver or Passenger Side

Item Number	OEM Part Number	Application	Pack
<b>42392 (NEW)</b>	A22-60713-002	Driver	1 Pc./Box
<b>42393 (NEW)</b>	A22-60713-001	Passenger	1 Pc./Box



## Peterbilt 387, 587 & Kenworth T2000, T700 Black Mirror Cover

### Description

- Black Mirror Cover for Peterbilt 385, 587 & Kenworth T2000, T700
- Sold Individually, Please Specify Driver or Passenger Side

Item Number	OEM Part Number	Application	Pack
<b>42777 (NEW)</b>	R59-1019-11	Driver	1 Pc./Box
<b>42778 (NEW)</b>	R59-1010-11	Passenger	1 Pc./Box



## 1997 - 2008 International 4700, 4900, 7100, 8100, 8200, 8300 Exterior Door Handle

### Description

- 1997 - 2008 International 4700, 4900, 7100, 8100, 8200, 8300 Exterior Door Handle

Item Number	OEM Part Number	Package	Pack
<b>42220B (NEW)</b>	3550931C91	Bulk	1 Pc./Bulk
<b>42211B (HOT)</b>	3550931C91	Bulk	1 Pc./Bulk



## 18" Stainless Steel "Boss" Steering Wheel

### Description

- 18" Stainless Steel "Boss" Steering Wheel
- Highly Polished Mirror, Stainless Steel Finish, Wheel Only
- Hub and Horn Assembly Sold Separately, Fits United Pacific Hub/Horn Assembly Only

Item Number	Description	Package	Pack
88215 (NEW)	4 Spoke "Boss"	Boxed	1 Pc./Box



## 18" Stainless Steel Steering Wheel

### Description

- 18" Stainless Steel Steering Wheel
- Highly Polished Mirror, Stainless Steel Finish, Wheel Only
- Hub and Horn Assembly Sold Separately, Fits United Pacific Hub/Horn Assembly Only

Item Number	Description	Package	Pack
88210 (HOT)	4 Spoke Steering Wheel	Boxed	1 Pc./Box



## 33 mm Thread-On "Moon" Front Axle Cover Set

### Description

- Chrome Plastic Front ABS Axle Cover Set with Unique "Moon" Design
- Universal Fit, Fits Most 11 1/4" Bolt Circle/Center Applications
- Fits Most 20", 22 1/2", and 24 1/2" Wheel, **33 mm Thread-On Nut Cover**
- New Solid One Piece Cover, Includes 1 Cover and 10 Nut Covers Per Kit
- Replacement Parts: 33 mm Thread-On Nut Cover (Item # 10064B)

Item Number	Description	Style	Pack
10253 (NEW)	33 mm Thread-On	Moon	1 Kit/Box



## Chrome Plastic "Moon" Rear Axle Cover

### Description

- Chrome Rear "Moon" Axle Cover with Removable Cap
- Vintage Moon Cap Design, Sleep Aerodynamic Look
- Universal Fit, Fits Most 11 1/4" Bolt Circle/Center Applications
- Fits Most 20", 22 1/2", and 24 1/2" Wheel
- Includes 1 Cover, 1 Cap, and Ten 33 mm Thread-On Nut Covers Per Kit

Item Number	Description	Style	Pack
10277 (HOT)	33 mm Thread-On	Moon	1 Kit/Box



## Chrome Splitter Button

### Description

- Chrome Splitter Button for Eaton Fuller Shifter
- Available for Eaton Fuller 13 and 15 Speed Shifter

Item Number	Description	Speed	Pack
<b>70265 (NEW)</b>	Fits Eaton A-6913	13	1 Pc./Card
<b>70270 (NEW)</b>	Fits Eaton A-6915	15	1 Pc./Card



## Chrome Range Selector Cover

### Description

- Chrome Plastic Range Selector Cover for Eaton Fuller Shift Knobs

Item Number	Description	Package	Pack
<b>70273 (HOT)</b>	Fits Eaton Fuller Shifter	Carded	1 Pc./Card



## Stainless Gearshift Knob Cover

### Description

- Stainless Gearshift Knob Cover for Eaton Fuller Shifter
- Also Fits United Pacific Item # 70176/70177

Item Number	Description	Package	Pack
<b>70176-2 (HOT)</b>	Gearshift Knob Cover	Carded	1 Pc./Card



## Chrome Gearshift Knob

### Description

- Chrome Aluminum Gearshift Knob for Eaton Fuller Shifter
- Available for 13/18 & 9/10 Speed Eaton Fuller Transmissions

Item Number	Description	Speed	Pack
<b>70176 (HOT)</b>	Gearshift Knob	13/18	1 Pc./Box
<b>70177 (HOT)</b>	Gearshift Knob	9/10	1 Pc./Box



## Chrome Lower Gearshift Cover

### Description

- Chrome Lower Gearshift Knob Cover for Eaton Fuller Shifter
- Available in Chrome Plastic or Chrome Steel

Item Number	Description	Finish	Pack
<b>41021 (HOT)</b>	Gearshift Cover	Plastic	1 Pc./Card
<b>41069 (HOT)</b>	Gearshift Cover	Steel	1 Pc./Card



41021



41069

## 24" x 24" Stainless Quarter Fender Set - Competition Series

### Description

- 24" x 24" Stainless Quarter Fender with Tube Bracket
- 430 Stainless Steel
- Internal Mounting System, Eliminates the Need for U-Bolts and Other External Hardware, Mounting Post Not Included
- Sold in Pairs, Color Retail Box Packaging

Item Number	Description	Package	Pack
<b>10585 (NEW)</b>	Quarter Fender Set	Boxed	1 Pair/Box



## Chrome Deluxe LED License Plate Frame

### Description

- Chrome Deluxe License Plate Frame with 5 Red LED Third Brake Light or 5 Amber LED Auxiliary Light, Includes 11 LED License Plate Light
- New Deluxe Vintage Design

Item Number	LEDs	Lens	Package	Pack
<b>50148 (NEW)</b>	5 Red	Red	Carded	1 Pc./Card
<b>50149 (NEW)</b>	5 Amber	Amber	Carded	1 Pc./Card

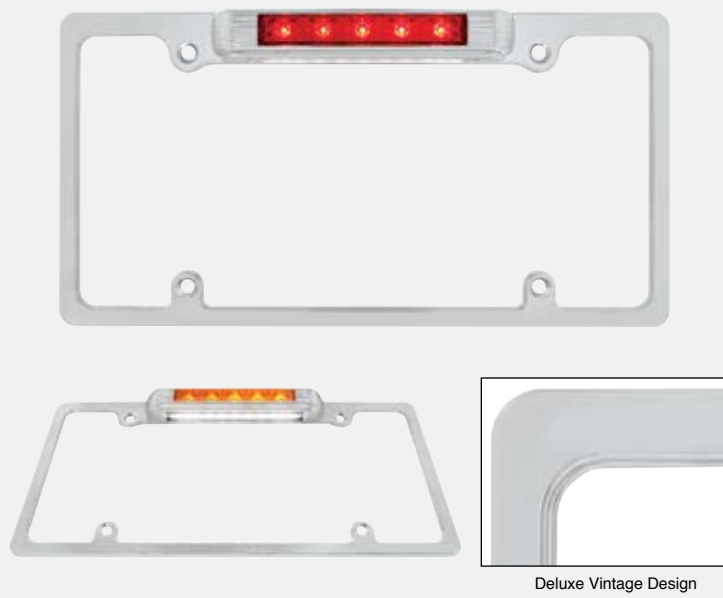

## Chrome Deluxe License Plate Frame

### Description

- Chrome Deluxe License Plate Frame
- New Deluxe Vintage Design

Item Number	Description	Package	Pack
<b>50139B (NEW)</b>	License Plate Frame	Bulk	1 Pc.



## 18" x 6" Top Mud Flap

### Description

- 18" x 6" Top Mud Flap for Item # 10702

Item Number	Description	Package	Pack
<b>10609 (NEW)</b>	18" x 6" Top Mud Flap	Bulk	1 Pc./Bulk

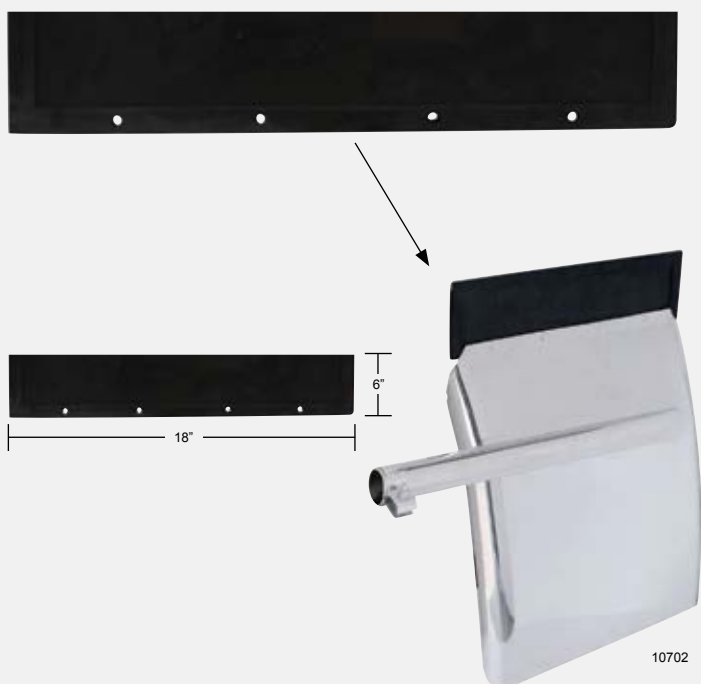

## Chrome Spike Fasteners

### Description

- Chrome Spike Fasteners, Perfect for License Plate
- Approximate Size: 3/4" Dia. x 1" L

Item Number	Description	Package	Pack
<b>10878 (NEW)</b>	Spike Fasteners	Carded	4 Pcs./Card





# WHAT'S NEW | SEP 2015

## Peterbilt 387, 587 & Kenworth T2000, T700 Mirror Assembly

### Description

- Mirror Assembly for Peterbilt 387, 587 & Kenworth T2000, T700 Series
- Includes Complete Mirror and Mounting Arm
- Electric Operation with Heat, Chrome or Black Mirror Cover
- Sold Individually, Please Specify Driver or Passenger Side

Item Number	Description	Application	Pack
42775 (NEW)	Black Mirror Assembly	Driver	1 Pc./Box
42776 (NEW)	Black Mirror Assembly	Passenger	1 Pc./Box
42773 (HOT)	Chrome Mirror Assembly	Driver	1 Pc./Box
42774 (HOT)	Chrome Mirror Assembly	Passenger	1 Pc./Box



## 2002+ International TranStar Corner Bumper Cover

### Description

- Corner Bumper Cover for 2002+ International TranStar
- Please Specify Driver or Passenger Side

Item Number	Application	OEM Number	Pack
20758 (NEW)	Driver	3559058C3	1 Pc./Box
20759 (NEW)	Passenger	3559059C3	1 Pc./Box



## Chrome Spike Axle Cover - 33 mm Thread-On

### Description

- Chrome Plastic Axle Cover with 33 mm Thread-On Spike Nut Cover
- Removable Dome Hub Cap

Item Number	Description	Application	Pack
10252 (NEW)	33 mm Thread-On	Front	1 Set/Box
10275 (HOT)	33 mm Thread-On	Rear	1 Set/Box



## Universal Front Hub Cap

### Description

- Chrome Steel Universal Notched Front Hub Cap with Hubdrometer Hole
- 1" Lip, Fits 4, 5, or 6 Notched Hubs, May Not Fit Some 4 Even Notched Hub

Item Number	Lip	Style	Material	Pack
10109 (NEW)	1"	Dome	Chrome	1 Pc.



# WHAT'S NEW | SEP 2015

## 15 Red LED Rectangular S/T/T Light Kit

### Description

- 15 Red LED Rectangular S/T/T Light Kit, Unique Lens Design
- Kit Includes Light (Item # 38747), Grommet (Item # 31516), and Plug (Items # 34216)

Item Number	LEDs	Lens	Package	Pack
<b>38747BRK (NEW)</b>	15 Red	Red	Bulk	1 Pc.



## Red Rectangular Quick Mount Reflector

### Description

- 3 1/4 x 1 9/16\" Rectangular Quick Mount Reflector
- Hermetically Sealed Acrylic Lens with Adhesive Backing

Item Number	Description	Package	Pack
<b>30708 (NEW)</b>	Red Quick Mount Reflector	Bulk	1 Pc.



## Incandescent Oval Crystal S/T/T Light

### Description

- Incandescent Oval Crystal Stop, Turn, and Tail Light

Item Number	Description	Package	Pack
<b>33539B (NEW)</b>	Oval Crystal S/T/T Light	Bulk	1 Pc.



## Submersible Combination Light Lens

### Description

- Submersible Combination Light Lens
- Designed with Acrylic Lens and Impact Resistant Housing
- Replacement Lens for Item # 31165K

Item Number	Description	Package	Pack
<b>33090 (NEW)</b>	Combination Light Lens	Bulk	1 Pc.

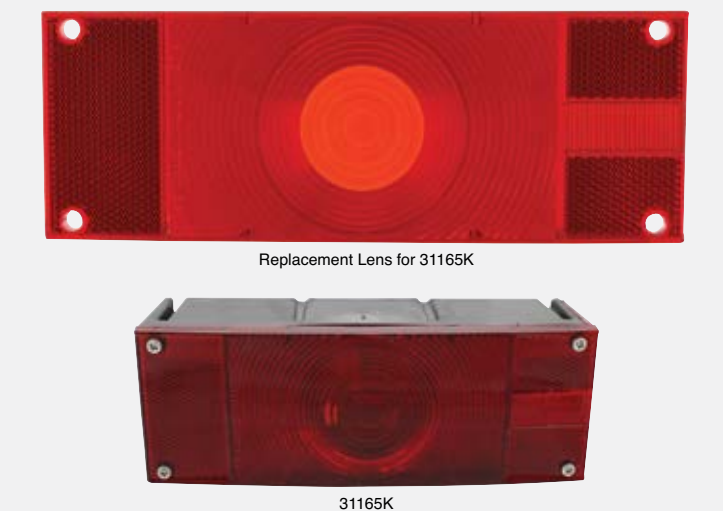



## Freightliner Columbia Projection Headlight

### Description

- Freightliner Columbia Projection Headlight
- Fits Various 1996+ Freightliner Columbia Models
- Unique Dual LED Position Light Bar, Available in Crystal Design
- Impact Resistant Polycarbonate Lens Provide Unparalleled Protection from Road Hazards
- DOT/SAE Approved
- Sold Individually, Please Specify Driver or Passenger Side, **1 Year Warranty**

Item Number	Application	Description	Pack
<b>31256 (NEW)</b>	Driver	Chrome	1 Pc./Box
<b>31257 (NEW)</b>	Passenger	Chrome	1 Pc./Box

### Technical Specifications

#### Low Beam Application

12V DC Input  
3.9 Amps / 46.8 Watt  
FMVSS 571

#### High Beam Application

12V DC Input  
4.5 Amps / 54 Watt  
FMVSS 571



## Volvo VN / VNL 2004+ Projection Headlight

### Description

- Volvo VN / VNL 2004+ and Newer Projection Headlight
- Unique Dual LED Position Light Bar, Available in Crystal or Blackout Design
- Impact Resistant Polycarbonate Lens Provide Unparalleled Protection from Road Hazards
- DOT/SAE Approved
- Sold Individually, Please Specify Driver or Passenger Side, **1 Year Warranty**

Item Number	Application	Description	Pack
<b>31263 (NEW)</b>	Driver	Chrome	1 Pc./Box
<b>31264 (NEW)</b>	Passenger	Chrome	1 Pc./Box
<b>31268 (NEW)</b>	Driver	Blackout	1 Pc./Box
<b>31269 (NEW)</b>	Passenger	Blackout	1 Pc./Box

### Technical Specifications

#### Low Beam Application

12V DC Input  
4.1 Amps / 49.2 Watt  
FMVSS 571

#### High Beam Application

12V DC Input  
4.5 Amps / 54 Watt  
FMVSS 571



## 5 LED 7" Dual Function Headlight

### Description

- 5 High Power LED 7" Headlight, PHILIPS LUMILEDS
- Reinforced Aluminum Reflector, Rugged Anti-Vibration Construction
- Improved Visibility with Whiter Light Output that is Closer to the Color Temperature of Daylight

Item Number	Description	Package	Pack
<b>31289 (NEW)</b>	Black 7" LED	Carded	1 Pc./Card
<b>31391 (NEW)</b>	Chrome 7" LED	Carded	1 Pc./Card



**HIGH POWER**  
15 WATT X 1  
LED

**HIGH POWER**  
3 WATT X 4  
LED

### Technical Specifications

#### Low Beam Application

- 12-24V DC Input
- 1.7 Amps @ 12.8V DC
- Lumen Output: 500
- FMVSS108 Compliant
- IP67 Rating

#### High Beam Application

- 12-24V DC Input
- 2.6 Amps @ 12.8V DC
- 1.3 Amps @ 28.0V DC
- Lumen Output: 1000
- FMVSS108 Compliant
- IP67 Rating

## 8 High Power 6 Watt LED Work Light

### Description

- 8 High Power 6 Watt LED Work Light
- 9V-80V Application, 2800 Lumens
- Mounting Studs are Approximately 4 5/16" Apart

Item Number	LEDs	Function	IP Rating	Pack
<b>36940B (NEW)</b>	6 Watt x 8	Flood	IP69K	1 Pc./Card



**HIGH POWER**  
6 WATT X 8  
LED

**LIGHT**  
2800  
LUMENS

**MULTIPLE**  
9V - 80V  
VOLTAGE

## 3 High Power LED Beacon Light

### Description

- 3 High Power LED Beacon Light
- 12V - 24V Application, 5 Flash Pattern
- Available in Magnet Mount or Permanent Mount
- SAE IPX6, Class 2 Rated

Item Number	Mount	Application	Flash Pattern
<b>36666 (NEW)</b>	Magnet Mount	12V - 24V	5
<b>36667 (NEW)</b>	Permanent Mount	12V - 24V	5



## 30 High Power LED Micro Strobe Warning Bar

### Description

- 30 High Power LED Micro Strobe Warning Bar
- 12V - 24V Application, 22 Flash Pattern
- Available in Magnet Mount or Permanent Mount
- SAEJ845, Class 1 Rated

Item Number	Mount	Application	Flash Pattern	Lens
<b>36921 (NEW)</b>	Magnet	12V - 24V	22	Clear
<b>37116 (HOT)</b>	Permanent	12V - 24V	22	Clear



**SAE J845**  
Class 1



## 14 LED 12" Auxiliary Warning Light

### Description

- 14 LED 12" Auxiliary Warning Light
- 3 Wire Hardwired, 6 Flash Pattern
- Mounting Holes Approximately 11 7/16" Apart, [Lifetime Warranty](#)

Item Number	LEDs	Lens	Flash Pattern	Pack
<b>37195B (NEW)</b>	14 White	Clear	6	1 Pc.
<b>37192B (HOT)</b>	14 Amber	Clear	6	1 Pc.
<b>37194B (HOT)</b>	14 Red	Clear	6	1 Pc.

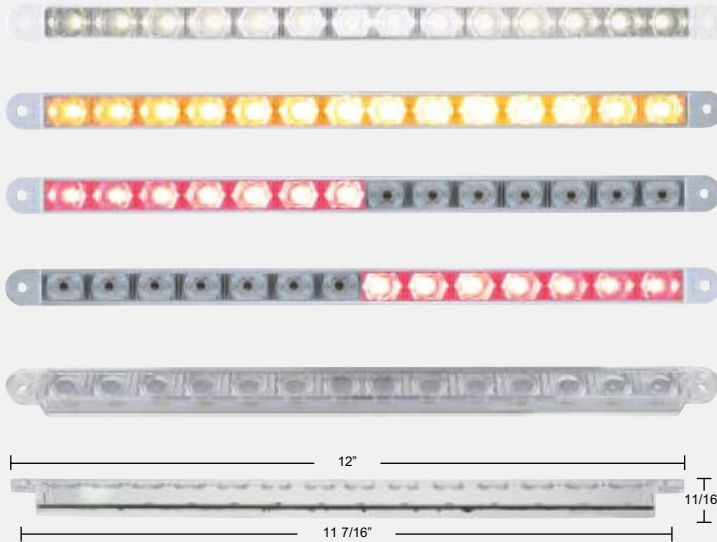

**Strobe Function**

## 14 LED 12" Auxiliary Warning Light with Chrome Bezel

### Description

- 14 LED 12" Auxiliary Warning Light with Chrome Plastic Bezel
- Available in Amber and Red LEDs with Clear Lens
- 6 Flash Pattern, Multiple Light Synchronization
- Mounting Screws Can Be Moved to Accommodate Mounting Distance from 4 1/2" - 7 3/8" Apart, Stainless Steel Mounting Hardware Included
- 12" Chrome Plastic Light Bar Bezel Available Separately: Item # 30933B

Item Number	LEDs	Lens	Flash Pattern	Pack
<b>36851 (NEW)</b>	14 White	Clear	6	1 Pc./Card
<b>37190 (HOT)</b>	14 Amber	Clear	6	1 Pc./Card
<b>37191 (HOT)</b>	14 Red	Clear	6	1 Pc./Card



**Strobe Function**

## 2 High Power LED "Hyper Mini" Pedestal Light

### Description

- 1W Rebel 3045 LED, 100% Waterproof Compact Design
- Heavy Duty Chrome Die-Cast Housing
- Vertical & Horizontal Mounting Application
- Universal Application, Install Anywhere

Item Number	LEDs	Lens	Package	Pack
<b>36673 (NEW)</b>	2 Amber	Clear	Carded	1 Pc./Card
<b>36675 (NEW)</b>	2 Red	Clear	Carded	1 Pc./Card
<b>36676 (NEW)</b>	2 White	Clear	Carded	1 Pc./Card



## 9 LED 2" Clearance/Marker Light Kit

### Description

- 2 Flat LED Clearance/Marker Light with 9 LEDs
- Available with 9 Amber LEDs or 9 Red LEDs with 2 Female Terminals
- Kit Includes Light, Grommet (Item # 31505) and Plug (Item # 34210)
- Recommended Plug: Item # 34210, [Lifetime Warranty](#)

Item Number	LEDs	Lens	Package	Pack
<b>38170BAK (NEW)</b>	9 Amber	Amber	Bag	1 Kit
<b>38171BRK (NEW)</b>	9 Red	Red	Bag	1 Kit



**Kit (Item # 38170BAK & 38171BRK) Includes**



## 21 LED 4" S/T/T & P/T/C Light - GLO Light

### Description

- 21 LED 4" Round S/T/T & P/T/C "GLO" Light
- Unique Patent Pending "GLO" Design
- Available in Red or Amber Lens, 3 Contact Female Plug
- Kit Includes Light, Grommet (Item # 31515) and Plug (Item # 34212)
- Recommended Plug: Item # 34212, [Lifetime Warranty](#)

Item Number	LEDs	Lens	Package	Pack
<b>37132B (HOT)</b>	21 Red	Red	Bulk	1 Pc.
<b>37132BRK (NEW)</b>	21 Red	Red	Bag	1 Kit
<b>37133B (NEW)</b>	21 Amber	Amber	Bulk	1 Pc.
<b>37133BAK (NEW)</b>	21 Amber	Amber	Bag	1 Kit



Kit (Item # 37132BRK & 37133BAK) Includes



## 10 LED 4" S/T/T & P/T/C Light

### Description

- 10 LED 4" Round S/T/T or P/T/C Light
- Available with 10 Amber LEDs or 10 Red LEDs with 3 Contact Female Plug
- Kit Includes Light, Grommet (Item # 31515) and Plug (Item # 34212)
- Recommended Plug: Item # 34212, [Lifetime Warranty](#)

Item Number	LEDs	Lens	Package	Pack
<b>38770BRK (NEW)</b>	10 Red	Red	Bag	1 Kit
<b>38771BAK (NEW)</b>	10 Amber	Amber	Bag	1 Kit

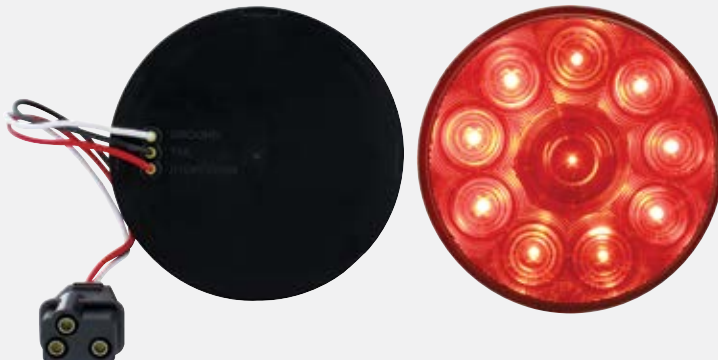

Kit (Item # 38770BRK & 38771BAK) Includes



## 10 LED 6" Oval S/T/T Light

### Description

- 10 LED 6" Oval S/T/T or P/T/C Light
- Available in Colored or Clear Lens, 3 Contact Female Plug
- Kit Includes Light, Grommet (Item # 31506) and Plug (Item # 34212)
- Recommended Plug: Item # 34212, [Lifetime Warranty](#)

Item Number	LEDs	Lens	Package	Pack
<b>36771B (NEW)</b>	10 Red	Red	Bulk	1 Pc.
<b>36771BRK (NEW)</b>	10 Red	Red	Bag	1 Kit



Kit (Item # 36771BRK) Includes



## 22 LED 6" Oval S/T/T & P/T/C Light - GLO Light

### Description

- 22 LED 6" S/T/T & P/T/C "GLO" Light
- Unique Patent Pending "GLO" Design
- Available in Red or Amber Lens, 3 Contact Female Plug
- Kit Includes Light, Grommet (Item # 31506) and Plug (Item # 34212)
- Recommended Plug: Item # 34212, [Lifetime Warranty](#)

Item Number	LEDs	Lens	Package	Pack
<b>37128B (NEW)</b>	22 Red	Red	Bulk	1 Pc.
<b>37128BRK (NEW)</b>	22 Red	Red	Bag	1 Kit
<b>37129B (NEW)</b>	22 Amber	Amber	Bulk	1 Pc.
<b>37129BAK (NEW)</b>	22 Amber	Amber	Bag	1 Kit

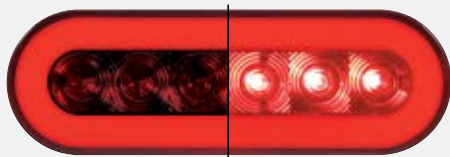

Kit (Item # 37128BRK & 37129BAK) Includes





## Freightliner Cascadia Front Side Fairing

### Description

- Front Side Fairing for Freightliner Cascadia
- Please Specify Driver or Passenger Side

Item Number	Application	OEM Number	Pack
<b>20732 (NEW)</b>	Driver	A22-61126-000	1 Pc./Box
<b>20733 (NEW)</b>	Passenger	A22-67791-003	1 Pc./Box



## Freightliner Cascadia Front Side Fairing Skirt

### Description

- Front Side Fairing for Freightliner Cascadia
- Please Specify Driver or Passenger Side

Item Number	Application	OEM Number	Pack
<b>20738 (NEW)</b>	Driver	A22-61139-000	1 Pc./Box
<b>20739 (NEW)</b>	Passenger	A22-67791-001	1 Pc./Box



## Chrome 7" Motorcycle Headlight - Grooved

### Description

- Chrome 7" Motorcycle Grooved Headlight
- Fits 1986-2011 Heritage, Fat Boy, and FLSTN Softail

Item Number	Housing	Bulb	Bulb Type
<b>32145 (NEW)</b>	32169	31379	34 White LED
<b>32146 (NEW)</b>	32169	31387	Crystal H4 Halogen
<b>32147 (NEW)</b>	32169	31378	34 Amber LED
<b>32149 (NEW)</b>	32169	S2010LED	10 Amber LED
<b>32156 (NEW)</b>	32169	31353	Blackout 11 LED
<b>32157 (NEW)</b>	32169	31355	Chrome 11 LED
<b>32158 (NEW)</b>	32169	31289	Blackout LED
<b>32159 (NEW)</b>	32169	31391	Chrome LED



## Chrome 7" Motorcycle Headlight Housing - Grooved

### Description

- Chrome 7" Motorcycle Headlight Housing
- Fits 1986-2011 Heritage, Fat Boy, and FLSTN Softail

Item Number	Description	Package	Pack
<b>32169 (NEW)</b>	7" Harley Headlight Housing	Boxed	1 Pc./Box



## Triangle Headlight

### Description

- Triangle Headlight with Black or Chrome Housing
- Available with 2 Different Back Housing, Custom Application

Item Number	Finish	Shape	Depth	Pack
<b>76996 (NEW)</b>	Chrome	Flat	3 1/4"	1 Pc./Box
<b>76997 (NEW)</b>	Black	Flat	3 1/4"	1 Pc./Box
<b>76998 (NEW)</b>	Chrome	Rounded	4 1/2"	1 Pc./Box
<b>76999 (NEW)</b>	Black	Rounded	4 1/2"	1 Pc./Box



## 15 LED 2 3/8" Harley Turn Signal

### Description

- 15 LED 2 3/8" Round Harley Signal Light with 1157 Plug
- Fits Original Harley Davidson Housing, Fits Various Years and Models
- Load Resistor (UP Item # 34205) Maybe Required for Proper Operation, **Lifetime Warranty**

Item Number	LEDs	Lens	Package	Pack
<b>36775 (NEW)</b>	15 Red	Red	Carded	1 Pc./Card
<b>36776 (NEW)</b>	15 Red	Clear	Carded	1 Pc./Card
<b>36777 (NEW)</b>	15 Red	Smoke	Carded	1 Pc./Card



## 29 LED Harley Motorcycle Tail Light w/ 4 LED License Light

### Description

- 29 LED Harley Motorcycle Tail Light with 4 LED License Light
- Completely Sealed Lighting Unit with 3157 Plug for OEM Socket
- Fits Original Harley Davidson Housing, Fits Various Years & Models
- Load Resistor (UP Item # 34205) Maybe Required for Proper Installation
- Lifetime Warranty**

Item Number	Description	Lens	Pack
<b>38669 (HOT)</b>	29 Red / 4 White	Red	1 Pc./Card
<b>37099 (HOT)</b>	29 Red / 4 White	Smoke	1 Pc./Card





## 4 LED 2" Clearance/Marker Light Kit - Flat/Low Profile

### Description

- 2" Low Profile Flat LED Clearance/Marker Light with 4 LEDs
- Available with 4 Amber LEDs or 4 Red LEDs with 2 Female Terminals
- Kit Includes Light, Grommet (Item # 31505) and Plug (Item # 34210)
- Recommended Plug: Item # 34210, [Lifetime Warranty](#)

Item Number	LEDs	Lens	Package	Pack
<b>38457BAK (NEW)</b>	4 Amber	Amber	Bag	1 Kit
<b>38458BRK (NEW)</b>	4 Red	Red	Bag	1 Kit



Kit (Item # 38457BAK & 38458BRK) Includes



## 9 LED 2" Clearance/Marker Light - Reflector

### Description

- 9 LED 2" Clearance/Marker Light with Reflector
- Available with 9 Amber LEDs or 9 Red LEDs with 2 Female Terminals
- Kit Includes Light, Grommet (Item # 31505) and Plug (Item # 34210)
- Recommended Plug: Item # 34210, [Lifetime Warranty](#)

Item Number	LEDs	Lens	Package	Pack
<b>38849BAK (NEW)</b>	9 Amber	Amber	Bag	1 Kit
<b>38850BRK (HOT)</b>	9 Red	Red	Bag	1 Kit



Kit (Item # 38849BAK & 38850BRK) Includes



## 9 LED 2" Clearance/Marker Light Kit - Flat / Low Profile

### Description

- 2" Low Profile Flat LED Clearance/Marker Light with 9 LEDs
- Available with 9 Amber LEDs or 9 Red LEDs with 2 Female Terminals
- Kit Includes Light, Grommet (Item # 31505) and Plug (Item # 34210)
- Recommended Plug: Item # 34210, [Lifetime Warranty](#)

Item Number	LEDs	Lens	Package	Pack
<b>38409BAK (NEW)</b>	9 Amber	Amber	Bag	1 Kit
<b>38411BRK (NEW)</b>	9 Red	Red	Bag	1 Kit



Kit (Item # 38409BAK & 38411BRK) Includes

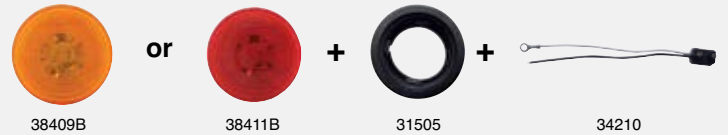

## 4 LED 2 1/2" Clearance/Marker Light Kit - Flat/Low Profile

### Description

- 2 1/2" Low Profile Flat LED Clearance/Marker Light with 4 LEDs
- Available with 4 Amber LEDs or 4 Red LEDs with 2 Female Terminals
- Kit Includes Light, Grommet (Item # 31505) and Plug (Item # 34210)
- Recommended Plug: Item # 34210, [Lifetime Warranty](#)

Item Number	LEDs	Lens	Package	Pack
<b>38465BAK (NEW)</b>	4 Amber	Amber	Bag	1 Kit
<b>38466BRK (NEW)</b>	4 Red	Red	Bag	1 Kit



Kit (Item # 38465BAK & 38466BRK) Includes

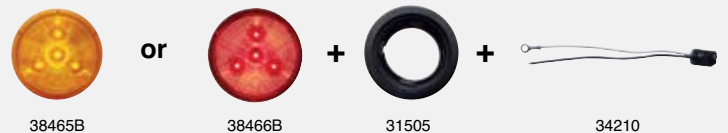

## 13 LED 2 1/2" Clearance/Marker Light Kit - Flat

### Description

- 2 1/2" Flat LED Clearance/Marker Light with 13 LEDs
- Available with 13 Amber LEDs or 13 Red LEDs with 2 Female Terminals
- Kit Includes Light, Grommet (Item # 31503) and Plug (Item # 34210)
- Recommended Plug: Item # 34210, [Lifetime Warranty](#)

Item Number	LEDs	Lens	Package	Pack
<b>38176BAK (NEW)</b>	13 Amber	Amber	Bag	1 Kit
<b>38177BRK (NEW)</b>	13 Red	Red	Bag	1 Kit

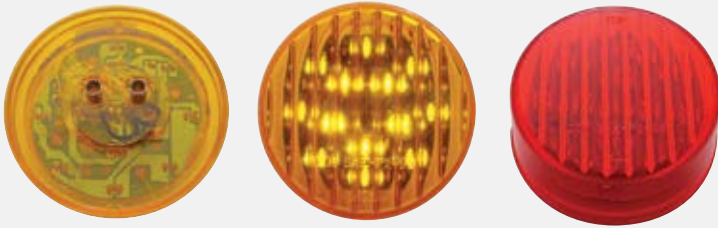

Kit (Item # 38176BAK & 38177BRK) Includes

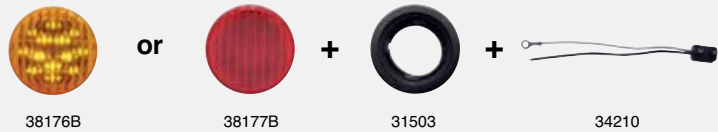

## 6 LED Clearance/Marker Light Kit

### Description

- 6 LED Small Rectangular Clearance/Marker Light Kit
- Available with 6 Amber LEDs or 6 Red LEDs
- Kit Includes Light, Bracket (Item # 33007) and Plug (Item # 34255)
- Recommended Plug: Item # 34255, [Lifetime Warranty](#)

Item Number	LEDs	Lens	Package	Pack
<b>38158BAK-B (NEW)</b>	6 Amber	Amber	Bag	1 Kit
<b>38159BRK-B (NEW)</b>	6 Red	Red	Bag	1 Kit



Kit (Item # 38158BAK-B & 38159BRK-B) Includes



## 12 LED Rectangular Clearance/Marker Light Kit

### Description

- 12 LED Rectangular Clearance/Marker Light Kit
- Available with 12 Amber LEDs or 12 Red LEDs
- Kit Includes Light, Bracket (Item # 33006), [Lifetime Warranty](#)

Item Number	LEDs	Lens	Package	Pack
<b>38161BAK-B (NEW)</b>	12 Amber	Amber	Bag	1 Kit
<b>38162BAK-B (NEW)</b>	12 Red	Red	Bag	1 Kit



Kit (Item # 38161BAK-B & 38162BAK-B) Includes

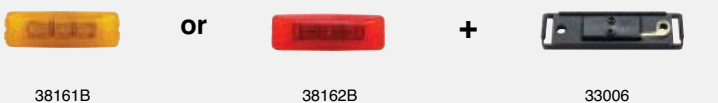

## 12 LED 4" S/T/T Light Kit - Bubble Lens

### Description

- 12 LED 4 " Round S/T/T Light
- 3 Contact Female Terminal
- Kit Includes Light, Grommet (Item # 31515) and Plug (Item # 34212)
- Recommended Plug: Item # 34212, [Lifetime Warranty](#)

Item Number	LEDs	Lens	Package	Pack
<b>38112BRK (NEW)</b>	12 Red	Red	Bag	1 Kit



Kit (Item # 38112BRK) Includes



## 12 LED 4" S/T/T Light Kit - Reflector

### Description

- 12 LED 4" Round S/T/T Light with Chrome Reflector
- 3 Contact Female Terminal
- Kit Includes Light, Grommet (Item # 31515) and Plug (Item # 34211)
- Recommended Plug: Item # 34211, [Lifetime Warranty](#)

Item Number	LEDs	Lens	Package	Pack
<b>38116BRK (NEW)</b>	12 Red	Red	Bag	1 Kit



Kit (Item # 38116BRK) Includes



## 30 LED 4" S/T/T Light

### Description

- 30 LED 4" Round S/T/T Light
- Available with 30 Red LEDs with 3 Contact Female Terminal
- Kit Includes Light, Grommet (Item # 31515) and Plug (Item # 34212)
- Recommended Plug: Item # 34212, [Lifetime Warranty](#)

Item Number	LEDs	Lens	Package	Pack
<b>39440BRK (NEW)</b>	30 Red	Red	Bag	1 Kit



Kit (Item # 39440BRK) Includes



## 12 LED Oval S/T/T Light Kit - Reflector

### Description

- 12 LED Oval S/T/T Light Kit with Chrome Reflector
- 3 Contact Female Terminal
- Kit Includes Light, Grommet (Item # 31506) and Plug (Item # 34216)
- Recommended Plug: Item # 34216, [Lifetime Warranty](#)

Item Number	LEDs	Lens	Package	Pack
<b>38121BRK (NEW)</b>	12 Red	Red	Bag	1 Kit



Kit (Item # 38121BRK) Includes



## 60 LED Oval S/T/T Light

### Description

- 60 LED 6" Oval S/T/T Light
- 3 Contact Female Plug
- Kit Includes Light, Grommet (Item # 31506) and Plug (Item # 34216)
- Recommended Plug: Item # 34216, [Lifetime Warranty](#)

Item Number	LEDs	Lens	Package	Pack
<b>38095B (NEW)</b>	21 Red	Red	Bulk	1 Pc.
<b>38095BRK (NEW)</b>	21 Red	Red	Bag	1 Kit



Kit (Item # 38095BRK) Includes



## 10 LED Oval P/T/C Light

### Description

- 10 LED 6" Oval P/T/C Light
- Hard Wired with 3 Contact Female Plug
- Kit Includes Light, Grommet (Item # 31506) and Plug (Item # 34211)
- Recommended Plug: Item # 34211, [Lifetime Warranty](#)

Item Number	LEDs	Lens	Package	Pack
<b>38775BAK (NEW)</b>	10 Amber	Amber	Bag	1 Kit



Kit (Item # 38775BAK) Includes



## 15 LED Rectangular S/T/T & P/T/C Light

### Description

- 15 LED Rectangular S/T/T & P/T/C Light, Unique Lens Design
- Available with 15 Amber LEDs or 15 Red LEDs with 2 Female Terminals
- Kit Includes Light, Grommet (Item # 31516) and Plug (Item # 34215)
- Recommended Plug: Item # 34215, [Lifetime Warranty](#)

Item Number	LEDs	Lens	Package	Pack
<b>38746BAK (NEW)</b>	15 Amber	Amber	Bag	1 Kit
<b>38747BRK (HOT)</b>	15 Red	Red	Bag	1 Kit



Kit (Item # 38746BAK & 38747BRK) Includes



## 16 LED 6" Oval P/T/C Light -Reflector

### Description

- 16 LED 6" Oval P/T/C Light with Chrome Reflector
- Available with 16 Amber LEDs with 3 Contact Female Terminal
- Kit Includes Light, Grommet (Item # 31506) and Plug (Item # 34215)
- Recommended Plug: Item # 34215, [Lifetime Warranty](#)

Item Number	LEDs	Lens	Package	Pack
<b>39341BAK (NEW)</b>	18 Amber	Amber	Bag	1 Kit



Kit (Item # 39341BAK) Includes



## 18 LED Mid-Trailer Turn Signal Light

### Description

- 18 LED 6" Mid-Trailer Turn Signal Light
- Available with 18 Amber LEDs with 3 Contact Female Terminal
- Kit Includes Light, Grommet (Item # 31506) and Plug (Item # 34215)
- Recommended Plug: Item # 34215, [Lifetime Warranty](#)

Item Number	LEDs	Lens	Package	Pack
<b>38920BAK (NEW)</b>	18 Amber	Amber	Bag	1 Kit



Kit (Item # 38920BAK) Includes



## LED Submersible Combination Light Kit - Reflector

### Description

- Submersible Combination Light with 12 Red LEDs + 3 Red LEDs (Side Marker)
- Rear Clearance Light for Over 80" Wide Application
- 3 Wires (White = Ground, Green = Stop/Turn, Brown = Tail/Marker/License)
- **Lifetime Warranty**

Item Number	LEDs	License Light	Package	Pack
<b>39551B (NEW)</b>	18+3 Red	No	Bulk	1 Pc.
<b>39552B (NEW)</b>	18+3 Red 5 White	Yes	Bulk	1 Pc.



## 12 LED 4" White Auxiliary/Utility Light - Reflector

### Description

- 12 White LED 4" Auxiliary/Utility Light with Reflector
- Available with 12 White LEDs with 2 Contact Female Terminal
- Kit Includes Light, Grommet (Item # 31515) and Plug (Item # 34211)
- Recommended Plug: Item # 34211, **Lifetime Warranty**

Item Number	LEDs	Lens	Package	Pack
<b>39510BCK (NEW)</b>	12 White	Clear	Bag	1 Kit



Kit (Item # 39510BCK) Includes



## LED Submersible Combination Light

### Description

- Submersible Combination Light with 12 Red LEDs + 4 Red LEDs (Side Marker) + 4 White LEDs (License Illuminator)
- Rear Clearance Light for Over 80" Wide Application
- 3 Wires (White = Ground, Green = Stop/Turn, Brown = Tail/Marker/License)
- Kit Includes Light, Bracket (Item # 33098) and Wires (Item # 90624)
- **Lifetime Warranty**

Item Number	LEDs	License Light	Package	Pack
<b>38309BK (NEW)</b>	24+8 Red 4 White	Yes	Bag	1 Kit
<b>38310B (NEW)</b>	12+4 Red	No	Bulk	1 Pc.
<b>38311B (NEW)</b>	12+4 Red 4 White	Yes	Bulk	1 Pc.

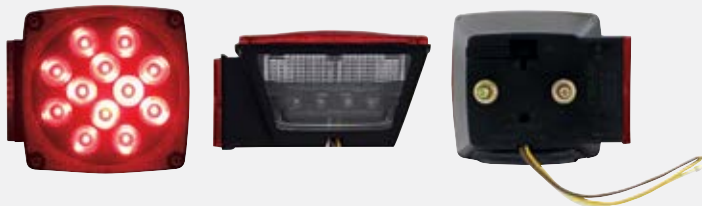

Kit (Item # 38309BK) Includes



## 35 LED Oval Sequential Auxiliary Signal Light Kit

### Description

- 35 LED Economy Sequential Oval Auxiliary Signal Light
- Electronics Completely Sealed in Epoxy to Resist Corrosion and Moisture
- Kit Includes Light, Grommet (Item # 31506) and Plug (Item # 34215)
- Recommended Plug: Item # 34215, **Lifetime Warranty**

Item Number	LEDs	Lens	Package	Pack
<b>38143BAK (NEW)</b>	35 Amber	Amber	Bag	1 Kit



Kit (Item # 38143BAK) Includes



## 10 LED 4" Auxiliary/Utility Light

### Description

- 10 Super Bright White LED 4" Auxiliary/Utility Light
- Available with 10 White LEDs with 2 Contact Female Plug
- Kit Includes Light, Grommet (Item # 31515) and Plug (Item # 34211)
- Recommended Plug: Item # 34211, [Lifetime Warranty](#)

Item Number	LEDs	Lens	Package	Pack
<b>38828BCK (NEW)</b>	10 White	Clear	Bag	1 Kit

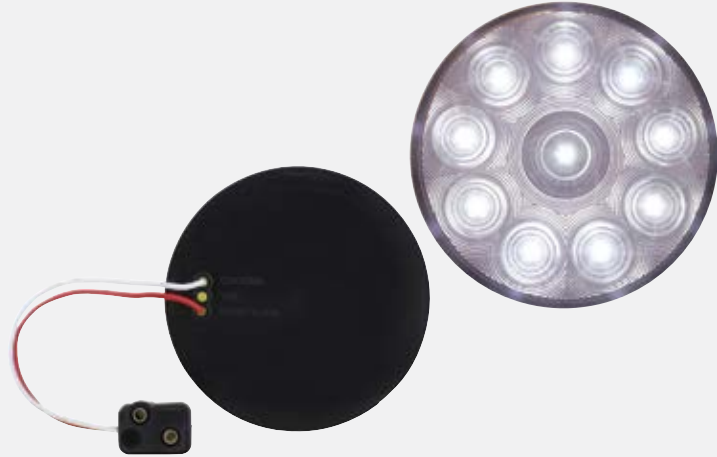

Kit (Item # 38828BCK) Includes



## 10 LED 6" Oval Utility Light

### Description

- 10 LED 6" Oval Utility Light
- 3 Contact Female Plug
- Kit Includes Light, Grommet (Item # 31506) and Plug (Item # 34215)
- Recommended Plug: Item # 34215, [Lifetime Warranty](#)

Item Number	LEDs	Lens	Package	Pack
<b>36773B (NEW)</b>	10 White	Clear	Bulk	1 Pc.
<b>36773BCK (NEW)</b>	10 White	Clear	Bag	1 Kit



Kit (Item # 36773BCK) Includes



## 28 LED Oval Back-Up Light

### Description

- 28 Super Bright White LED Oval Back-Up Light
- Available with 28 White LEDs with 3 Pin Male Terminals
- Kit Includes Light, Grommet (Item # 31506) and Plug (Item # 34270)
- Recommended Plug: Item # 34270, [Lifetime Warranty](#)

Item Number	LEDs	Lens	Package	Pack
<b>38551BCK (NEW)</b>	15 White	Clear	Bag	1 Kit



Kit (Item # 38551BCK) Includes



## 15 LED Rectangular Auxiliary/Utility Light

### Description

- 15 Super Bright White LED Rectangular Auxiliary/Utility Light
- Available with 15 White LEDs with 3 Contact Female Terminals
- Kit Includes Light, Grommet (Item # 31516) and Plug (Item # 34215)
- Recommended Plug: Item # 34215, [Lifetime Warranty](#)

Item Number	LEDs	Lens	Package	Pack
<b>38778BCK (NEW)</b>	15 White	Clear	Bag	1 Kit



Kit (Item # 38778BCK) Includes



# WHAT'S NEW | NOV 2015

## Chrome 2008+ Freightliner Cascadia Mesh Grill with Bug Screen

### Description

- Chrome Mesh Grill with Bug Screen for 2008+ Freightliner Cascadia
- Approximately 34 1/2" L x 57 1/2" W

Item Number	Description	Package	Pack
<b>21078 (NEW)</b>	Mesh Cascadia Grill	Boxed	1 Pc./Box



## 7" Crystal Headlight with LED Halo Ring

### Description

- 7" Crystal Headlight with LED Halo Ring and 9007 Bulb
- Reinforcement Multi-Surfaced, Aluminum Reflector
- Available with Amber or White LED Halo Ring

Item Number	Description	Package	Pack
<b>31284 (NEW)</b>	Amber LED Halo Ring	Boxed	1 Pc./Box
<b>31285 (NEW)</b>	White LED Halo Ring	Boxed	1 Pc./Box



## 6" x 4" Rectangular High Power LED Projection Headlight

### Description

- 11 High Power LED Projection Headlight with White LED Position Light
- Improve Visibility with Light Output That is Closer to the Color Temperature of Daylight
- Die Cast Aluminum Housing Provides Maximum Protection from the Elements
- Solid State Design Resists Shock and Vibration

Item Number	Description	Package	Pack
<b>31274 (NEW)</b>	Low Beam	Boxed	1 Pc./Box
<b>31275 (NEW)</b>	High Beam	Boxed	1 Pc./Box

### Technical Specifications

9-33V DC Input Low Beam Application 9-33V DC Input Low Beam Application  
 1.8 Amps / 24 Watt 0.8 Amps / 23 Watt  
 FMVSS 108 FMVSS 108



Projector Lens



White LED Light Bar

## "Blackout" 2008+ Freightliner Cascadia Headlight Assembly

### Description

- "Blackout" Headlight Assembly for 2008+ Freightliner Cascadia
- Sold in Pair

Item Number	Description	Package	Pack
<b>31207 (NEW)</b>	Black Cascadia Headlight	Boxed	1 Pair/Box



**BLACKOUT**



# WHAT'S NEW | NOV 2015

## 1990-07 Mack CH600, 1992-99 Mack CL600, 1993-07 Mack CL700 Headlight Assembly

### Description

- Headlight Assembly for 1990-07 Mack CH600, 1992-99 Mack CL600, 1993-07 Mack CL700
- Sold Individually, Please Specify Driver or Passenger Side

Item Number	Application	OEM Number	Pack
<b>31208 (NEW)</b>	Driver	25154252	1 Pc./Box
<b>31209 (NEW)</b>	Passenger	25163253	1 Pc./Box



## 7 LED 4" S/T/T & P/T/C Light - Deep Dish

### Description

- 7 Super Bright LED Deep Dish S/T/T & P/T/C Light, Flange Mount
- 3 Contact Female Terminal, Available in Color or Clear Lens
- Recommended Plug: Item # 34212/34216, [Lifetime Warranty](#)

Item Number	LEDs	Lens	Package	Pack
<b>36913 (NEW)</b>	Red	Red	Carded	1 Pc./Card
<b>36914 (NEW)</b>	Red	Clear	Carded	1 Pc./Card
<b>36915 (NEW)</b>	Amber	Amber	Carded	1 Pc./Card
<b>36916 (NEW)</b>	Amber	Clear	Carded	1 Pc./Card



## Square LED Combination Light - GLO Light

### Description

- Include Stop, Turn, Tail, and License Light Function
- Unique Patent Pending "GLO" Design, Halo Effect on Running, ALL LEDs Lit on Stop
- Two Bolt Mount On are 2" Apart, Hard Wired with 3 Wires
- [Lifetime Warranty](#)

Item Number	LEDs	License Light	Package	Pack
<b>36912 (NEW)</b>	24+1 Red	No	Carded	1 Pc./Card
<b>36911 (NEW)</b>	24+1 Red 3 White	Yes	Carded	1 Pc./Card



**GloLight™**  
Stand Out

## Universal Stud Mount LED Combination Light - GLO Light

### Description

- Include Stop, Turn, Tail, Backup, and License Light Function
- Unique Patent Pending "GLO" Design, Halo Effect on Running, ALL LEDs Lit on Stop
- Stud Mount, Hard Wired with 4 Wires
- [Lifetime Warranty](#)

Item Number	LEDs	License Light	Package	Pack
<b>36910 (NEW)</b>	30+6 White	No	Carded	1 Pc./Card
<b>36909 (NEW)</b>	30+6 White 3 White	Yes	Carded	1 Pc./Card



**GloLight™**  
Stand Out





# WHAT'S NEW | NOV 2015

## 23 SMD LED 17 1/4" S/T/T & P/T/C Light Bar with Reflector

### Description

- 23 SMD LED 17 1/4" S/T/T & P/T/C Light Bar with Reflector
- Available in Amber or Red LEDs with Colored or Clear Lens, Approximate Size: 17 1/4" L x 1" W
- Mounting Hole Approximately 16 1/8" Apart, **Lifetime Warranty**

Item Number	LEDs	Lens	Package	Pack
<b>37089 (NEW)</b>	23 Amber	Amber	Carded	1 Pc./Card
<b>37090 (NEW)</b>	23 Red	Red	Carded	1 Pc./Card
<b>37091 (NEW)</b>	23 Amber	Clear	Carded	1 Pc./Card
<b>37092 (NEW)</b>	23 Red	Clear	Carded	1 Pc./Card

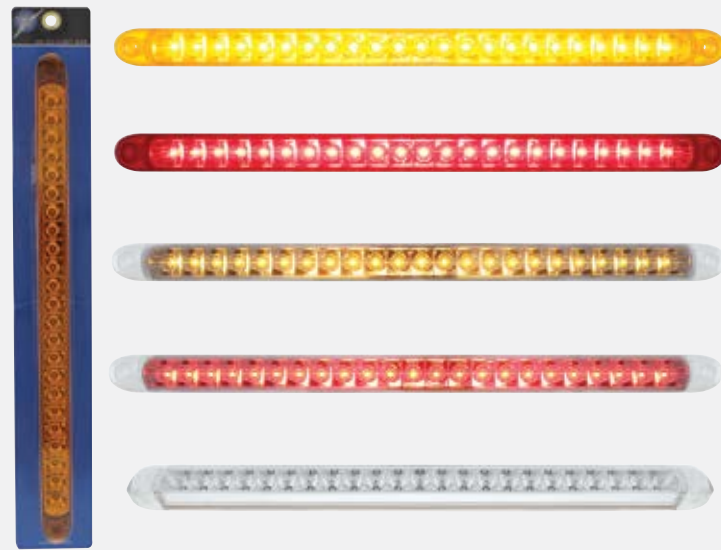

## 4 High Power 3 Watt LED Compact Work Light

### Description

- 4 High Power 3 Watt LED Compact Work Light
- 9V-32V Application, 700 Lumens
- Compact Design only Measures 2 13/16" x 4 3/4" x 1 1/8"

Item Number	LEDs	Function	IP Rating	Pack
<b>36854 (NEW)</b>	3 Watt x 4	Flood	IP69K	1 Pc./Card



<b>LIGHT</b> <b>700</b> <b>LUMENS</b>	<b>MULTIPLE</b> <b>9V - 32V</b> <b>VOLTAGE</b>	<b>HIGH POWER</b> <b>3 WATT X 4</b> <b>LED</b>
---	--	--

## 3 High Power LED Compact Work Light

### Description

- 3 High Power 3 Watt LED Round Work Light
- 9V-32V Application, 600 Lumens
- Compact Design only Measures 3 3/8" x 5 3/8" x 2 1/4"

Item Number	LEDs	Function	IP Rating	Pack
<b>37074 (NEW)</b>	3 Watt x 3	Flood	IP67	1 Pc./Card



<b>LIGHT</b> <b>600</b> <b>LUMENS</b>	<b>MULTIPLE</b> <b>9V - 32V</b> <b>VOLTAGE</b>	<b>HIGH POWER</b> <b>3 WATT X 3</b> <b>LED</b>
---	--	--

## 5.5 Watt High Power LED 4 1/2" Spot Light

### Description

- Two 5.5 Watt High Power "Cree" XPE LED
- Easy Installation, Fits Any 5 3/4" Round Light Housing and Plug into Existing Wiring

Item Number	LEDs	Function	IP Rating	Pack
<b>36964 (NEW)</b>	5.5 Watt x 2	Spot	IP65	1 Pc./Box



<b>LIGHT</b> <b>400</b> <b>LUMENS</b>	<b>MULTIPLE</b> <b>12V</b> <b>VOLTAGE</b>	<b>HIGH POWER</b> <b>5.5 WATT X 2</b> <b>LED</b>
---	---	--



# WHAT'S NEW | NOV 2015

## High Power LED 194 / T10 Bulb

### Description

- High Power 12V 194 / T10 LED Bulb
- "Cree" LED

Item Number	LEDs	Bulb Type	Package	Pack
<b>36917 (NEW)</b>	Amber	194 / T10	Carded	2 Pcs./Card
<b>36918 (NEW)</b>	Blue	194 / T10	Carded	2 Pcs./Card
<b>36919 (NEW)</b>	Red	194 / T10	Carded	2 Pcs./Card
<b>36920 (NEW)</b>	White	194 / T10	Carded	2 Pcs./Card



## Kenworth T600/T660/T800 Series Mirror Replacement Parts

### Description

- Mirror Replacement Parts for Kenworth T600/T660/T800 Series
- Main (Item # 42780) and Lower Replacement Mirror (Item # 42781) Available with Defrost Function
- Available with Mirror Frame (Item # 42782)

Item Number	Description	OEM Number	Pack
<b>42780 (NEW)</b>	Main Mirror w/Defrost	M015400	1 Pc./Box
<b>42781 (NEW)</b>	Lower Mirror w/Defrost	SR59-6117-18	1 Pc./Box
<b>42782 (NEW)</b>	Mirror Frame w/Defrost	M015399	1 Pc./Box

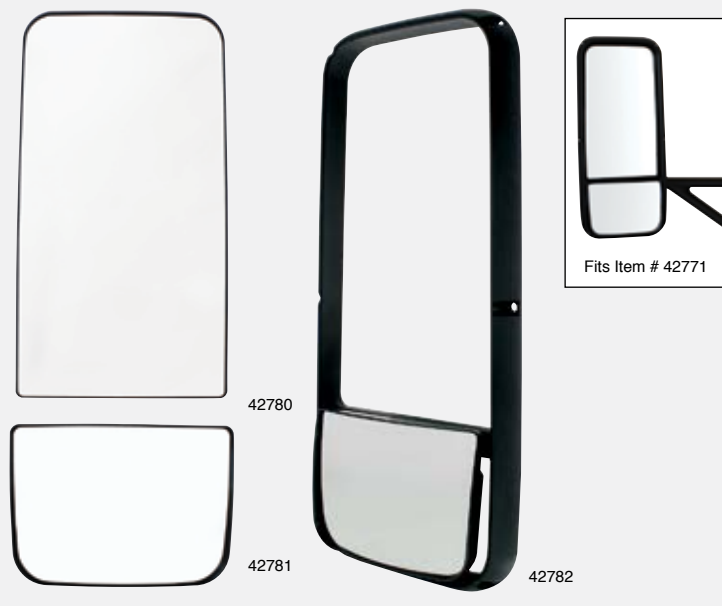

## Chrome Dagger Air Valve Knob

### Description

- Chrome Aluminum Screw On Air Valve Knob
- Available with Skull or Dagger Style
- Fits on Freightliner, Kenworth, Peterbilt and Various Other Trucks

Item Number	Style	Finish	Package	Pack
<b>23578 (NEW)</b>	Skull	Chrome	Carded	1 Pc./Card
<b>23525 (HOT)</b>	Plain	Chrome	Carded	1 Pc./Card



## Skull Air Valve Knob

### Description

- Skull Screw On Air Valve Knob
- Available in Chrome or Black Finished

Item Number	Style	Finish	Package	Pack
<b>23054 (NEW)</b>	Skull	Black	Carded	1 Pc./Card
<b>23058 (HOT)</b>	Skull	Chrome	Carded	1 Pc./Card



# WHAT'S NEW | NOV 2015

## Skull Biker 13/18 Speed Shift Knob

### Description

- Skull Biker Shift Knob
- Fits 13/18 Speed Gearshift Knobs, Machined Grip
- Available in Chrome or Black Finished
- Mounting Adaptor: Item # 70603B and Skull Knob: Item # 70658 (Black)/70629B (Chrome) Available Separately
- **\*Patent Pending\***

Item Number	Style	Finish	Package	Pack
<b>70669 (NEW)</b>	Skull	Black	Boxed	1 Pc./Box
<b>70642 (HOT)</b>	Skull	Chrome	Boxed	1 Pc./Box



## Skull Biker Shift Knob

### Description

- Skull Biker Shift Knob
- Available in Chrome or Black Finished
- Ultra High Quality Chrome Finish, Machined Grip
- Universal Hex Screw Mount Design, Includes Mounting Hardware

Item Number	Style	Finish	Package	Pack
<b>70658 (NEW)</b>	Skull	Black	Boxed	1 Pc./Box
<b>70629B (HOT)</b>	Skull	Chrome	Boxed	1 Pc./Box



## "Challenger" 13/18 Speed Shift Knob

### Description

- "Challenger" Pistol Grip Shift Knob
- Fits 13/18 Speed Gearshift Knobs, Machined Grip
- Available in Chrome or Black Finished
- Mounting Adaptor: Item # 70603B and "Challenger" Pistol Grip Knob: Item # 70656 (Black)/70626 (Chrome) Available Separately
- **\*Patent Pending\***

Item Number	Style	Finish	Package	Pack
<b>70667 (NEW)</b>	Pistol	Black	Boxed	1 Pc./Box
<b>70636 (HOT)</b>	Pistol	Chrome	Boxed	1 Pc./Box



## Pistol Grip Shift Knob

### Description

- Skull Biker Shift Knob
- Available in Chrome or Black Finished
- Ultra High Quality Chrome Finish, Machined Grip
- Universal Hex Screw Mount Design, Includes Mounting Hardware

Item Number	Style	Finish	Package	Pack
<b>70656 (NEW)</b>	Pistol	Black	Boxed	1 Pc./Box
<b>70626 (HOT)</b>	Pistol	Chrome	Boxed	1 Pc./Box



## Skulls Pistol Grip 13/18 Speed Shift Knob

### Description

- Skulls Pistol Grip Shift Knob
- Fits 13/18 Speed Gearshift Knobs, Machined Grip
- Available in Chrome or Black Finished
- Mounting Adaptor: Item # 70603B and Skulls Pistol Grip Knob: Item # 70657 (Black)/70646(Chrome) Available Separately

Item Number	Style	Finish	Package	Pack
<b>70668 (NEW)</b>	Skull Pistol	Black	Boxed	1 Pc./Box
<b>70655 (HOT)</b>	Skull Pistol	Chrome	Boxed	1 Pc./Box



## Skulls Pistol Grip Shift Knob

### Description

- Skulls Pistol Grip Shift Knob
- Available in Chrome or Black Finished
- Ultra High Quality Chrome Finish, Machined Grip
- Universal Hex Screw Mount Design, Includes Mounting Hardware

Item Number	Style	Finish	Package	Pack
<b>70657 (NEW)</b>	Skull Pistol	Black	Boxed	1 Pc./Box
<b>70646 (HOT)</b>	Skull Pistol	Chrome	Boxed	1 Pc./Box



## Chrome Flame Horn Button Bezel

### Description

- Chrome Flame Horn Button Bezel
- Unique Patent Pending Flame Design
- Horn Button Not Included
- Horn Button Available Separately: Item # 88210

Item Number	Description	Package	Pack
<b>88223 (NEW)</b>	Flame Steering Hub	Carded	1 Pc./Card



## 28" Spring Loaded Mud Flap Hanger - 45° Angled

### Description

- 28" Spring Loaded Mud Flap Hanger, 45° Angled
- Available in Chrome or Black, Capped End

Item Number	Bolt Center	Finish	End Cap	Pack
<b>10860 (NEW)</b>	1 1/8"	Chrome	Capped	1 Pair/Box
<b>10861 (NEW)</b>	1 1/8"	Black	Capped	1 Pair/Box



# WHAT'S NEW | DEC 2015

## 18" Steering Wheel

### Description

- 18" Steering Wheel with Chrome Spoke
- Steering Wheel Only, **Hub and Horn Assembly Available Separately**
- Mix and Match with United Pacific Hub and Designer Horn Bezel for a Unique and Distinctive look

Item Number	Color	Style	Package	Pack
<b>88226 (NEW)</b>	Blue	Boss	Boxed	1 Pc./Box
<b>88229 (NEW)</b>	Red	Boss	Boxed	1 Pc./Box
<b>88240 (NEW)</b>	Blue	Lady	Boxed	1 Pc./Box
<b>88241 (NEW)</b>	Red	Lady	Boxed	1 Pc./Box
<b>88242 (NEW)</b>	Blue	Flame	Boxed	1 Pc./Box
<b>88243 (NEW)</b>	Red	Flame	Boxed	1 Pc./Box
<b>88244 (NEW)</b>	Blue	GT	Boxed	1 Pc./Box
<b>88245 (NEW)</b>	Red	GT	Boxed	1 Pc./Box
<b>88246 (NEW)</b>	Blue	Blade	Boxed	1 Pc./Box
<b>88247 (NEW)</b>	Red	Blade	Boxed	1 Pc./Box
<b>88224 (HOT)</b>	Blue	4 Spoke	Boxed	1 Pc./Box
<b>88225 (HOT)</b>	Red	4 Spoke	Boxed	1 Pc./Box

**Boss**



**Lady**



**Flame**



**GT**



**Blade**



**4 Spoke**



**Color Retail Packaging**

## 9 High Power 3 Watt LED Work Light - Competition Series

### Description

- 9 High Power 3 Watt LED Round Work Light, Competition Series
- 12V-30V Application, 1700 Lumens, **3 Years Warranty**

Item Number	LEDs	Function	IP Rating	Pack
<b>36671 (NEW)</b>	3 Watt x 9	Flood	IP68	1 Pc./Card



**LIGHT 1700 LUMENS** **MULTIPLE 12V - 30V VOLTAGE** **HIGH POWER 3 WATT X 9 LED**

**COMPETITION SERIES**

## 9 High Power 3 Watt LED Work Light - Competition Series

### Description

- 9 High Power 3 Watt LED Work Light, Competition Series
- 12V-30V Application, 1700 Lumens, **3 Years Warranty**

Item Number	LEDs	Function	IP Rating	Pack
<b>36672 (NEW)</b>	3 Watt x 9	Flood	IP68	1 Pc./Card



**LIGHT 1700 LUMENS** **MULTIPLE 12V - 30V VOLTAGE** **HIGH POWER 3 WATT X 9 LED**

**COMPETITION SERIES**



# WHAT'S NEW | DEC 2015

## 10 LED 9" Auxiliary Light Bar

### Description

- 10 LED 9" Auxiliary Light Bar, 3 Wire Hardwired
- Mounting Holes Approximately 8 1/2" Apart, **Lifetime Warranty**

Item Number	LEDs	Application	Package	Pack
<b>38005B (NEW)</b>	10 White	Clear	Bulk	1 Pc.

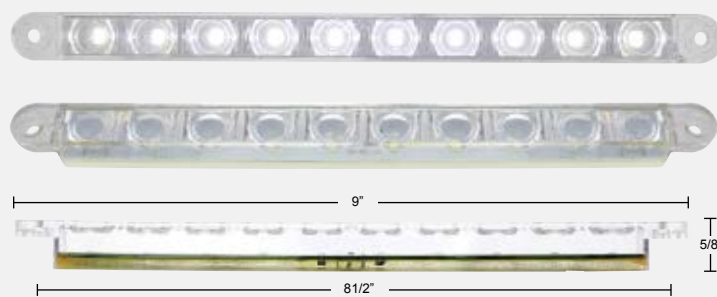

## 10 LED 9" Auxiliary Light Bar with Bezel

### Description

- 10 LED 9" Auxiliary Light Bar with Bezel, 3 Wire Hardwired
- Mounting Screws Can Be Move to Accommodate Mounting Distance from 4 1/2" - 7 3/8" Apart
- 9" Chrome Plastic Light Bar Bezel Available Separately: Item # 30932B

Item Number	LEDs	Application	Package	Pack
<b>36542 (NEW)</b>	10 White	Clear	Carded	1 Pc./Card



## Chrome Deluxe LED License Plate Frame

### Description

- License Frame with 10 LED 9" Light Bar
- 10 White LED with Clear Lens
- New Deluxe Vintage Design
- Chrome Deluxe License Plate Frame Available Separately: Item # 50139B

Item Number	LEDs	Application	Package	Pack
<b>36541 (NEW)</b>	10 White	Clear	Carded	1 Pc./Card



## 3 High Power LED Super Thin Warning Light

### Description

- 3 High Power LED Super Thin Directional Warning Light, Only 3/8" Tall
- 12V - 24V Application, 12 Flash Pattern, 3 Wire Hardwired
- Surface Mount, Mounting Holes are 3" Apart
- Approximate Size: 3 3/8" L x 1 1/16" W x 3/8" H, **Lifetime Warranty**

Item Number	LEDs	Application	Flash Pattern	Pack
<b>36852B (NEW)</b>	3 Amber	Clear	12	1 Pc.
<b>36853B (NEW)</b>	3 White	Clear	12	1 Pc.



## 3 High Power LED Super Thin Warning Light

### Description

- 3 High Power LED Super Thin Warning Light, Only 1/4" Tall
- 12V - 24V Application, 12 Flash Pattern, 3 Wire Hardwired
- Surface Mount, Mounting Holes are 3" Apart
- Approximate Size: 3 1/2" L x 1 13/16" W x 1/4" H, **Lifetime Warranty**

Item Number	LEDs	Application	Flash Pattern	Pack
<b>36630B (NEW)</b>	3 Amber	Clear	12	1 Pc.
<b>36631B (NEW)</b>	3 White	Clear	12	1 Pc.



# WHAT'S NEW | DEC 2015

## Chrome 2008+ Freightliner Cascadia Winter Guard Edition Grill with Bug Screen

### Description

- Chrome Grill with Bug Screen for 2008+ Freightliner Cascadia Winter Guard Edition Trucks
- Includes 10 Snaps for Application of Vinyl Winter Guard
- White Vinyl Winter Guard Sold Separately: Item # 21149
- Approximately 57 3/4" L x 34" W

Item Number	Description	Package	Pack
<b>21150 (NEW)</b>	Grill for Winter Guard Edition	Boxed	1 Pc./Box



Snaps

## 2008+ Freightliner Cascadia White Vinyl Front Winter Guard

### Description

- Front Winter Guard for 2008+ Freightliner Cascadia
- 6 Slot Winter Front Guard
- Fits Grill: Item # 21150

Item Number	Description	Package	Pack
<b>21149 (NEW)</b>	Cascadia Front Guard	Boxed	1 Pc./Box



## Black Freightliner Columbia Grill with Bug Screen

### Description

- Black Plastic Grill with Bug Screen for Freightliner Columbia
- Columbia (2000 - 2008)/Columbia 112 (2003 - 2014)/Columbia 120 (2000 - 2014)
- Approximately 48" L x 24 1/2" W

Item Number	Description	Package	Pack
<b>21455 (NEW)</b>	Black Columbia Grill	Boxed	1 Pc./Box



## International DuraStar and WorkStar Grill with Bug Screen

### Description

- Chrome Plastic Grill for International DuraStar 4100, 4200, 4300, 4400, 1300FBC, RXT, WorkStar 7300, WorkStar 7400, 8500
- Unique Curved Grill Design, Includes Bug Screen
- Approximately 57" L x 25" W

Item Number	OEM Part Number	Pack
<b>21148 (NEW)</b>	3564289C91, 3564289C99	1 Pc./Box



# WHAT'S NEW | DEC 2015

## Chrome 2002+ Freightliner Columbia Main Mirror

### Description

- Chrome Main Mirror for 2002+ Freightliner Columbia
- Manual Operation, Chrome Mirror Cover: Item # 42406
- Electric Operation with Heat, Chrome Mirror Cover: Item # 42407, 42408
- Sold Individually, Please Specify Driver or Passenger Side

Item Number	Operation	Defrost	Application	Pack
<b>42406 (NEW)</b>	Manual	No	-	1 Pc./Box
<b>42407 (NEW)</b>	Electric	Yes	Driver	1 Pc./Box
<b>42408 (NEW)</b>	Electric	Yes	Passenger	1 Pc./Box



## Chrome 2002+ Freightliner Columbia Small Auxiliary Mirror

### Description

- Chrome Small/Auxiliary Wide Angle Mirror for 2002+ Freightliner Columbia
- Manual Operation, Chrome Mirror Cover

Item Number	Description	Defrost	Pack
<b>42409 (NEW)</b>	Manual Operation	No	1 Pc./Box
<b>42410 (NEW)</b>	Manual Operation	Yes	1 Pc./Box



## Chrome 2002+ Freightliner Columbia Mirror Assembly

### Description

- Chrome Mirror Assembly for 2002+ Freightliner Columbia
- Includes Complete Mirror, Mounting Arm, and CB Mount
- Electric Operation with Heat, Chrome Mirror Cover
- Sold Individually, Please Specify Driver or Passenger Side

Item Number	OEM Part Number	Application	Pack
<b>42402 (NEW)</b>	A22-54992-002	Driver	1 Pc./Box
<b>42403 (NEW)</b>	A22-54992-005	Passenger	1 Pc./Box



## Chrome Freightliner M2 Exterior Mirror Assembly

### Description

- Chrome Mirror Assembly for Freightliner M2
- Includes Complete Mirror, Mounting Arm, and CB Mount
- Electric Operation with Heat, Chrome Mirror Cover
- Sold Individually, Please Specify Driver or Passenger Side

Item Number	OEM Part Number	Application	Pack
<b>42411 (NEW)</b>	A22-59615-014, A22-59615-006	Driver	1 Pc./Box
<b>42412 (NEW)</b>	A22-59615-015, A22-59615-007	Passenger	1 Pc./Box





## International 2002+ Bumper - Small Tow Hole

### Description

- Bumper for 2002 and Newer International Durastar & WorkStar Trucks with Small Tow Hole
- Available in Chrome or Black Finish
- Also Fit International 4400, 4300, 4200, 4100, 7400, 7300, 8600, 8500 Models
- **Oversize Freight Policy**

Item Number	Finish	Description	Pack
<b>20704 (NEW)</b>	Chrome	International Bumper	1 Pc./Box
<b>20705 (NEW)</b>	Black	International Bumper	1 Pc./Box



20704



20705



## Chrome Freightliner Cascadia Instrument Cover

### Description

- Chrome Plastic Center Instrument Cover for Freightliner Cascadia

Item Number	Description	Package	Pack
<b>42372 (NEW)</b>	Instrument Cover	Carded	1 Pc./Card



## Chrome Designer Air Valve Knob

### Description

- Chrome Designer Screw-On Air Valve Knobs in 6 Unique Design
- Machined Grip
- Mounting Adaptor Available Separately: Item # 23008B

Item Number	Description	Package	Pack
<b>23090 (NEW)</b>	"Austin" Air Valve Knob	Card	1 Pc./Card
<b>23091 (NEW)</b>	"Brooklyn" Air Valve Knob	Card	1 Pc./Card

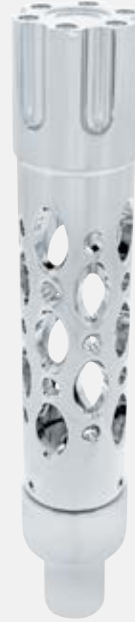

23090



23091

## Custom Chrome Shift Knob

### Description

- Custom Chrome Shift Knobs with Designer Grip
- Design for Custom Modification of Modern Single Stick Shifter to Old School Dual Stick Shift System
- Mounting Adaptor Available Separately: Item # 70625B

Item Number	Description	Package	Pack
<b>70670 (NEW)</b>	Austin Shift Knob	Bag	1 Pc./Bag
<b>70671 (NEW)</b>	Brooklyn Shift Knob	Bag	1 Pc./Bag



70670



70671



# WHAT'S NEW | DEC 2015

## 1973 - 79 Ford Truck & 1978 - 79 Ford Bronco Tail Light Lens

### Description

- Great Looking Replacement Lens
- Injection Molded from High Quality Polycarbonate Plastic
- Sold Individually, Please Specify Drivers Side or Passenger Side

Item Number	Description	Package	Pack
110112 (NEW)	Driver/Left Hand	Boxed	1 Pc./Box
110113 (NEW)	Passenger/Right Hand	Boxed	1 Pc./Box



## 1988 - 02 Chevy & GMC Truck Tail Light

### Description

- Great Looking Replacement Lens
- Injection Molded from High Quality Polycarbonate Plastic
- Sold Individually, Please Specify L/H Drivers Side or R/H Passenger Side
- Fits 1988-98 Chevy C/K Truck & 99-02 Chevy Silverado Classic
  - 1992-99 Chevy Suburban / GMC Suburban
  - 1995-99 Chevy Tahoe / GMC Yukon / GMC Denali (Full-size)
  - 1992-94 Chevy Blazer (Full-size) & GMC Jimmy (Full-size)

Item Number	Description	Package	Pack
110114 (NEW)	Driver/Left Hand	Boxed	1 Pc./Box
110115 (NEW)	Passenger/Right Hand	Boxed	1 Pc./Box



## Wire Harness - .180 Female Plug x 100' (13" Lead)

### Description

- 100' Long with 13" Lead
- Approximately 92 Plugs

Item Number	Description	Package	Pack
34249 (NEW)	.180 Female Plug x 100'	Bag	1 Pc./Bag

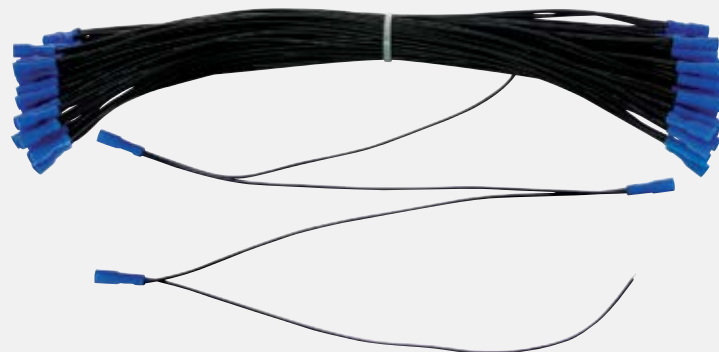

## Quarter Fender/Mud Flap Hanger Display

### Description

- Quarter Fender/Mud Flap Hanger Display

Item Number	Description	Package	Pack
99068 (HOT)	Quarter Fender Display	Bulk	1 Set



\*Quarter Fender & Mud Flap are not included. Available Separately.

NEW DESIGN



# TERMS & CONDITIONS

IMPORTANT: PLEASE REVIEW CAREFULLY

## New Accounts

Initial minimum buy-in is \$5,000 (or to be determined by United Pacific Industries, UPI hereafter). All initial orders must be prepaid in advance by Cashier's Check or VISA/MC. All new/potential accounts must complete a UPI "New Customer Info/Credit Form" and follow the Dealer Qualification Instructions. Upon completion of the credit application, approved accounts will be assigned payment terms of NET 30 Days (from invoice date). Accounts denied a credit line will be required to prepay in advance by Cashier's Check or VISA/MC.

## Payment Terms:

### Term Accounts

Accounts with NET 30 Days terms are required to submit payment within the 30 days from the date of invoice. Acceptable forms of payment include checks, ACH (Automated Clearing House), or wire transfer.

A service charge of 1.5% per month will be imposed on invoices not paid within the 30 day term. Delinquent accounts will be required to pay Cash-In-Advance (CIA). Checks will be accepted but orders will not be released until the check is cleared by the bank. Past due invoices will delay current orders. Please check with UPI on your account status when placing an order.

### Credit Cards

Accounts denied credit terms may pay by Visa or MasterCard. Credit card will be charged upon shipment. Credit card payments will not be accepted once an order has been shipped. UPI does not accept American Express or Discover card. A service fee of 3% will be charged on credit card orders.

### COD

A \$12.50 fee will be assessed per COD box for all FedEx/UPS COD shipments. Truck COD shipment fees are to be determined later by trucking company.

### Returned Checks:

A \$30 NSF (Non Sufficient Fund) fee will be assessed on each incidence a check is returned to UPI.

## ORDERING GUIDELINES

Placing Orders: New orders may be placed by any of the following methods

1. Fax: (888) 986-5988
2. E-mail: [sales@uapac.com](mailto:sales@uapac.com)
3. Telephone: In order to minimize errors, customers are encouraged to submit their orders by fax or email. Telephone orders should be limited to smaller orders such as add-ons to orders already submitted and/or fill-ins occurring between larger restocking orders.

## Changes to Orders:

Whenever possible, revisions to orders - additions or deletions of items - should also be submitted via fax or email to reduce the possibility of errors.

Additions/Deletion of items will only be accepted within 48 hours after the initial order date and/or before 12:00PM on the date of the shipment. Additions of items placed after the 48 hours time period will be considered a new order and adhere to a new order freight prepaid policy. Deletions of item cannot happen after the 48 hours time period and/or after 12:00PM on the date of the shipment. Please note additions and/or deletions of items will delay the shipment date.

## Canceling Orders:

Cancellation of orders must be submitted via fax or email within 24 hours of the order date. If the order has already shipped it will be the customers responsibility to return the order at the customers own expense. A restocking fee may apply, please see "Return" policy for further detail.

## Backorders:

Customers have the option of having their backorders shipped or cancelled. Backorders resulting from a freight prepaid qualifying order will be shipped freight prepaid. UPI reserves the right to cancel backorders that are 6 months or older from the initial invoice date.

## Minimum Order:

A minimum order of \$50.00 is required. Orders below \$50.00 will be assessed a minimum order fee of \$10.00.

## Packaging:

A 10% service charge will be added to orders with special packaging or UPC barcoding requirements.

## Lead Times:

Standard lead time for all United Pacific orders is 1-3 business days from the receipt of the purchase order. Larger orders may require a lead time of up to 5 business days. Transit time of 3-5 business days must be considered when placing orders. UPI cannot be responsible for delays in shipment after an order leaves our warehouse. UPI will work to resolve delays with freight

forwarding firms, however, delays do arise from time to time due to weather and unforeseen circumstances beyond UPI's control. Express order are exempted; please view Freight/Shipping Policy for further detail.

## Order Confirmation:

United Pacific will acknowledge receipt of orders by email/fax/telephone within 1 business day of receipt. If confirmation is not received, please contact UPI to ensure your order was received.

## FREIGHT

### Prepaid Freight:

Stock orders between \$50 and \$999.99 (US Lower 48 States), **\$50 and \$2499.99 (Alaska and Hawaii)**, **\$50 and \$1499.99 (Canada)**, [all price net US\$], will be shipped FOB Long Beach, California. Stock orders of \$1,000 (US Lower 48 States), **\$2500 (Alaska and Hawaii)**, **\$1500 (Canada)**, [based on UPI current pricing], or more will be shipped Freight Prepaid Ground to a single location only. (See exception for Oversize Items\*). *Express Air orders, Special Net Pricing orders, and Special Quote Pricing orders are excluded.* United Pacific reserves the right to select the carrier of our choice. Customers may select the carrier of their choice at their own expense, negotiated rates and insurance. Special handling charges such as lift gate fee, residential delivery fees are not included in the prepaid freight policy. If customers elect to choose their own freight carrier, orders will be shipped via FREIGHT COLLECT.

**\*Oversize Freight Policy** – Applies to bumpers, bumper covers, grills, fairings, fenders, and any exceptionally large or heavy item. 2 options:

1. Freight will be prepaid by United Pacific if the total order of all items exceeds **\$4,000 (US Lower 48 States)** or **\$5000 (Hawaii, Alaska and Canada)**, [all price net US\$]. There will not be additional charges for these items included on the order.
2. Freight will be prepaid by United Pacific if a customer orders a total of **\$2,500 (US Lower 48 States)** or **\$3500 (Hawaii, Alaska and Canada)**, [all price net US\$], of bumpers, bumper covers, grills, fairings, fenders, and any exceptionally large or heavy item. If the order is below **\$2,500 (US Lower 48 States)** or **\$3500 (Hawaii, Alaska and Canada)**, United Pacific will add freight charges to the order for the oversize items.

### Will Call Orders:

Will Call orders can be picked up 2 - 4 hours after placing the order. Customers should always call ahead to confirm when order will be ready to pick up.

# SHIPPING POLICY / CLAIMS

IMPORTANT: PLEASE REVIEW CAREFULLY

## SHIPPING POLICY

### International Shipments:

Shipments to locations outside the continental United States will be shipped to the customer's shipping agent or broker within the continental United States in accordance with the US freight policy. International customers will be responsible for the duties and taxes of their respective country.

### Express Orders:

All express orders, such as Next Day, Second Day, 3 Day Service & Will Call, must be faxed/mailed. Order confirmation will be faxed to the customer for final approval. If confirmation is not received, please contact UPI to ensure your order was received. Customers are required to sign off on express orders and fax confirmation back to UPI. Cut off for express order is 12:00PM. Express orders received after 12:00PM may or may not ship the same day. Please call UPI to confirm projected shipping date or will call time.

Due to the high cost of express shipments, customer may request UPI to call to confirm freight charges. If customer does not request confirmation, UPI will ship the express order.

### Drop Shipments:

All drop shipment orders will be assessed a \$10.00 processing fee. Drop shipment processing fee will be automatically added to the invoice without notice. All drop shipment orders must be faxed in. No freight allowance or prepaid freight will be permitted for any drop shipments, thus, all drop ship orders, regardless of order size, are FOB Long Beach, CA.

## CLAIMS

### General Policy:

All claims (Shortage, Mis-Shipped, Damage, Overage, Customer Error & Billing Error) must be submitted to UPI within 3 business days of the receipt of shipment. Claims submitted beyond 3 business days of the receipt of shipment will be voided by UPI.

On all shipments, the person who signs and receives the shipment is responsible for noting on the Bill of Lading, in writing, whether any boxes arrived damaged or shorted. Failure to do so will void all claim rights between all parties. UPI will have no recourse against the trucking company if customer does not note any damages or shortages on the Bill of Lading.

The customers receiving department must count and sign for the exact number of boxes received. Failure to follow the above instructions will void all claim rights between all parties.

### Shortages / Mis-Ships / Damages

While UPI strives to fill every order with 100% accuracy, on occasion an item may get shipped in error or get damaged during shipping. In the event this occurs, please follow the process below. Note: This type of claim must be reported to UPI within three (3) business days of receiving the order.

1. Contact the United Pacific office to initiate the claim. To make it easy for you we have two acceptable methods for requesting the claim:

\* By e-mail : [returns@uapac.com](mailto:returns@uapac.com)

\* By fax : (888) 986-5988

\* **Note: To ensure you receive a timely credit, we cannot accept claim requests by phone.**

2. You will be required to provide the following information:

- \* Your business name
- \* Contact name and telephone number (in case we have questions)
- \* Date the order was received
- \* A copy of the Packing List / Invoice noting the item number and quantity that was shipped in error or damaged during shipping.
- \* Special instructions you have for us.

3. UPI will send a return label so you can ship the items back.

4. Once we receive the miss-shipped/damaged item(s) a credit will be issued to your account on the next billing cycle.

5. Shortages will be credit to the Customers' account, unless customer would like the shortages replaced.

### Overages:

UPI strives to provide our customers with the best customer service and products, in turn we would greatly appreciate any help from customer in notifying UPI of any shipping overages. Customers will be offered the option of retaining the merchandise or returning the merchandise to UPI at UPI's expense. If the items are to be returned, an RMA number and return shipping label will be provided.

### Customer Errors:

Any item or quantity ordered in error by the customer may be returned by contacting UPI for a RMA No.

1. To make it easy for you we have two acceptable methods for requesting the RMA:

\* By e-mail: [returns@uapac.com](mailto:returns@uapac.com)

\* By fax: (888) 986-5988

\* **Note: To ensure you receive a timely RMA credit, we cannot accept RMA requests by phone.**

2. You will be required to provide the following information.

- \* Your business name
- \* Contact name and telephone number (in case we have questions)
- \* A list of the items number and quantity ordered in error
- \* Special instructions you have for us

3. UPI will review the request to ensure the products are within the return period.

4. Once we have validated the request, United Pacific will issue an RMA number to the customer. In issuing the RMA approval, the following conditions will apply :

\* Returned items are subject to a 20% re-stocking fee.

\* Return shipping costs are the responsibility of the customer.

\* Items must not have any retail/price sticker on exterior packaging or they will be returned to the customer at customer's expense and no credit given.

\* Items must be in good condition with original packaging intact or they will be returned to the customer at customer's expense and no credit given.

\* Allow up to 30 days for the credit to be issued from the time the returned items are received.

### Billing Errors:

Billing errors should be reported to UPI within 3 business days of invoice receipt. Customers are asked to provide the invoice number, part number, and quantities in question. Once verified, UPI will issue a credit or an invoice for the difference in billing error.

# WARRANTY POLICY / RETURNS

IMPORTANT: PLEASE REVIEW CAREFULLY

## WARRANTY POLICY

### General Policy:

UPI offers a NO HASSLE WARRANTY RETURN policy to all our customers. Warranty claims can only be submitted through an authorized UPI Distributor. UPI warranty is not transferable and applies to the original installation and purchase only. In no event shall UPI be liable for incidental or consequential damages, nor shall UPI be liable for any claims or damages arising out of or connected with the UPI warranty exceed the purchase price of the products. There are no warranties, expressed or implied (including any warranty of merchantability or fitness) that extend beyond this warranty. The warranty does not apply to costs associated with the loss of use of the product, loss of time, inconvenience, commercial loss, incidental or consequential damages. UPI reserves the right to alter the designs of products without assuming any obligation to modify previously manufactured products and will only replace warranted products with redesigned products.

Warranty does not apply to merchandise that has been drilled, cut, welded, modified in any way or installed contrary to normal installation and usage. In addition, UPI cannot be held liable for damages caused by road hazards, accidents, misuse, neglect, abuse or corrosive environments including acid washes and highway snow/ice chemicals which can cause discoloration and corrosion in aluminum, chrome, stainless steel and light products. UPI reserves the right to credit returned merchandise at the initial purchase price or at the current selling price, which price ever is lower.

### Aluminum / Chrome / Stainless Steel Products:

All aluminum, chrome, and stainless steel products carry a limited 6 month warranty (from invoice date) against defects in material or workmanship.

### Lighting Products:

#### Incandescent

All incandescent lighting products carry a limited 12 month warranty (from invoice date) against defects in material or workmanship. The limited 12 month warranty does not apply to several applications, such as, buses, construction equipment, and off road vehicles.

#### LED

All LED lighting products carry a specific Limited\* Warranty (from invoice date) against defects in material or workmanship.

- \* LED Marker, 2", 2-1/2", 4", 7", Oval & Square Lights - Varies from 2 years to 10 years to Limited Lifetime, depending on specific item. The housing, bezel or mounting base on any light made from Chrome/Stainless carries a 6 month limited warranty.
- \* LED Cab Lights and Kits, Double/Single Stud Turn Signal and PB/KW/FL/VL or non-make Turn Signals and any/all Strip Lights - Varies from 2 years to 10 years to Limited Lifetime, depending on specific item. The housing, bezel or mounting base on any light made from Chrome/Stainless carries a 6 month limited warranty.
- \* LED Beacon, Driving, Headlights, Work & Warning Lights - Varies from 6 months to 3 years. The housing, bezel or mounting base on any light made from Chrome/Stainless carries a 6 month limited warranty.
- \* All LED Accessory Lights (Honda, Stainless Steel Double/Single face Lights, Interior Lights, License Plate Lights, and any Accent Lights. The housing, bezel or mounting base on any light made from Chrome/Stainless carries a 6 month limited warranty.

## RETURNS

### General Policy:

All returns must be authorized by UPI. All return requests must be faxed or e-mailed ([returns@uapac.com](mailto:returns@uapac.com)) A RMA number (Return Merchandise Authorization Number) will be provided. Returns not possessing a valid

RMA number are subject to rejection and will be returned to sender at the customer's expense.

All customers are encouraged to use the Warranty RMA Claim Form.

### Defective Goods / Warranty Return:

UPI offers our customers a No Hassle Warranty Return. Please follow the instructions below for requesting a RMA for defective goods:

1. If any warranty issues occur, simply contact the UPI for RMA number. To make it easy for you we have two acceptable methods for requesting the RMA:
  - \* By e-mail: [returns@uapac.com](mailto:returns@uapac.com)
  - \* By fax: (888) 986-5988
  - \* **Note: To ensure you receive a timely RMA credit, we cannot accept RMA requests by phone.**
2. You will be required to provide the following information:
  - \* Your business name
  - \* Contact name and telephone number (in case we have questions)
  - \* A list of the defective item number and quantity with the nature/ reason of the defect
  - \* Special instructions you have for us
  - \* The enclosed fax form may be used for your convenience to request an RMA
3. UPI will review the request to ensure the products are within the stated warranty period.
4. Once we have validated the warranty items, a RMA confirmation, listing the items and cost will be faxed to the customer within 3 business days. UPI will process the credit to your account within 30 days.

**Note: There will be no need to return the warranty product to us. However, from time to time, UPI may require some warranty products to be shipped back so we may analyze the cause of the failure. All warranty products that are required to be shipped back will be freight prepaid by UPI.**

### Stock Return

United Pacific Industries encourages all customers to regularly monitor the sales volume and stock level of their inventory items. As sales trends may slow the movement of specific items, our hope is that those items are featured as "close-out specials" as to minimize stock returns. We also understand that the customer, from time to time, may accumulate over-stock items and desire to return those. Therefore, we have adopted the following policy below.

#### NOTE:

- \* Items must have been purchased by the dealer requesting the stock return.
- \* Items must have been purchased within the preceding 12 months.
- \* Items that have been discontinued will not be considered for return.

1. Contact the United Pacific office for RMA number. We have 2 acceptable methods for requesting the RMA:

By e-mail : [returns@uapac.com](mailto:returns@uapac.com)

By fax : (888) 986-5988

\***Note: To ensure you receive a timely RMA credit, we cannot accept RMA requests by phone.**

2. You will be required to provide the following information:
  - \* Your business name
  - \* Contact name and telephone number (in case we have questions)
  - \* A list of defective items: Item numbers and quantity of each
  - \* Special instructions you have for us
3. Your claim will be reviewed within 5 business days and you will be contacted by your sales representative who will discuss solutions to liquidate these slow moving items.

# RETURNS / CATALOGS / DISCLAIMER

IMPORTANT: PLEASE REVIEW CAREFULLY

4. In the event United Pacific and the customer agree to a credit in lieu of returning the items, this credit will be issued within 10 business days.

5. In the event items are returned by the customer, United Pacific will issue an RMA number to the customer. In issuing the RMA approval, the following conditions will apply:

- \* Returned items are subject to a 20% re-stocking fee.
- \* Return shipping costs are the responsibility of the customer.
- \* Items must not have any retail/price sticker on exterior packaging or they will be returned to the customer at customer's expense and no credit given.
- \* Items must be in good condition with original packaging intact or they will be returned to the customer at customer's expense and no credit given.
- \* Allow up to 30 days for the credit to be issued from the time the returned items are received

6. Stock returns may be requested throughout the year and are subject to a maximum of 5% of prior year annual purchases.

## Closeout/Discontinue Items:

UPI will not warranty or accept returns on Closeout/Discontinue items.

### Procedure:

An inventory of the merchandise being returned must accompany each return. The RMA number should be prominently displayed on each carton/box.

All Returns must be returned freight prepaid.

### Ship Returns to:

United Pacific Industries  
Attn: Returns Department  
3788 E. Conant St.  
Long Beach, CA 90808

### RMA's:

Outstanding RMA's will be automatically cancelled if not used within 30 days of issuance.

## CATALOGS

### General Policy:

UPI will send a set of catalogs and price lists upon the arrival any new catalogs and price list. Included in the mailing will be a Catalog Order Form in which customers can request additional copies.

### Catalog/CD Request:

UPI provides additional catalogs/CD's to our customers free of charge. Customer must submit their request on a UPI Catalog Order Form or add the request to their regular restocking order. Requests for additional catalogs/CD's should be submitted along with the regular restocking orders to avoid additional freight charges. Due to the availability of catalogs/CD's, customer's request may be limited to certain quantity. Catalogs/CD's will be shipped along with the customers' order. Customer may request the catalogs be shipped separately, but customer will be responsible for the freight charge.

### Picture Request

All UPI item pictures are taken professionally by our marketing department. Item pictures can be downloaded online at [www.uapac.com](http://www.uapac.com). Item pictures not posted online can be requested by sending an email to [e-mail\\_graphic@uapac.com](mailto:e-mail_graphic@uapac.com). All picture requests must state the item no and the format of the picture file, i.e jpeg or high resolution. UPI has over 20,000 SKU's and therefore does not have a CD with all the items.

## DISCLAIMER

United Pacific Industries reserves the right to amend or update our Policies & Procedures without notice.

## RMA FORM SAMPLE

**DEFECTIVE GOODS / WARRANTY CLAIM FORM**

UNITED PACIFIC INDUSTRIES, INC.  
3788 E. CONANT ST.  
LONG BEACH, CA 90808  
DIRECT: (562) 421-5888  
TOLL FREE: (800) 766-5888  
TOLL FREE FAX: (800) 886-5888

Date: \_\_\_\_\_  
Company Name: \_\_\_\_\_  
Address: \_\_\_\_\_  
City, State, Zip: \_\_\_\_\_  
Contact Name: \_\_\_\_\_  
Phone Number: \_\_\_\_\_  
Fax Number: \_\_\_\_\_  
E-mail: \_\_\_\_\_

Item #	Quantity	Description	Reason for Defect	Date sold to Customer
1				
2				
3				
4				
5				
6				
7				
8				
9				
10				

Any special notes / instructions for United Pacific (list here): \_\_\_\_\_

State Received: \_\_\_\_\_ Final RMA: \_\_\_\_\_  
RMA Approval Date: \_\_\_\_\_ Credit Amount: \_\_\_\_\_  
RMA Number: \_\_\_\_\_ Approved By: \_\_\_\_\_

## CATALOG ORDER FORM SAMPLE

**UNITED PACIFIC CATALOG ORDER FORM**

UNITED PACIFIC INDUSTRIES, INC.  
3788 E. CONANT STREET  
LONG BEACH, CA 90808  
TEL: (562) 421-5888  
FAX: (888) 866-5888  
TOLL FREE: (800) 766-5888

Date: \_\_\_\_\_  
Company Name: \_\_\_\_\_  
Address 1: \_\_\_\_\_  
Address 2: \_\_\_\_\_  
City, State, Zip: \_\_\_\_\_  
Contact Name: \_\_\_\_\_

Item #	Description	Quantity	Total
1	CDKW1 UP INTERIOR PRODUCT CATALOG - KENWORTH, CD ROM EDITION		
2	CDPB1 UP INTERIOR PRODUCT CATALOG - PETERBILT, CD ROM EDITION		
3	UCAC1 UP AIR CLEANER CATALOG, 1 <sup>ST</sup> EDITION		
4	UCEH1 UP EXHAUST CATALOG 1 <sup>ST</sup> EDITION		
5	UCFL2 UP INTERIOR PRODUCT CATALOG - FREIGHTLINER, 2 <sup>ND</sup> EDITION		
6	UCFM2 UP FENDER, REAR LT BARR/PANEL, MUD FLAP ACCESSORIES, 2 <sup>ND</sup> EDITION		
7	UCIH1 UP INTERNATIONAL PRODUCT CATALOG, 1 <sup>ST</sup> EDITION		
8	UCKS2 UP KEYSTONE POLISHING CATALOG, 2 <sup>ND</sup> EDITION		
9	UCKW2 UP INTERIOR PRODUCT CATALOG - KENWORTH, 2 <sup>ND</sup> EDITION		
10	UCLT2 UP MASTER LIGHTING CATALOG, 2 <sup>ND</sup> EDITION		
11	UCMFL1 UP MINI FREIGHTLINER INTERIOR PRODUCT CATALOG		
12	UCMKW1 UP MINI KENWORTH INTERIOR PRODUCT CATALOG		
13	UCMKW1S UP MINI SPANISH KENWORTH INTERIOR PRODUCT CATALOG		
14	UCMPB1 UP MINI 2006+ PETERBILT INTERIOR PRODUCT CATALOG		
15	UCNW2 UP NUT COVER & WHEEL PRODUCT CATALOG, 2 <sup>ND</sup> EDITION		
16	UCPB2 UP INTERIOR PRODUCT CATALOG - PETERBILT, 2 <sup>ND</sup> EDITION		
17	UCSC2 UP SPECIALTY COLLISION CATALOG 2 <sup>ND</sup> EDITION		
18	UCTH2 UP TRAIN HORN & AIR COMPRESSOR CATALOG, 2 <sup>ND</sup> EDITION		
19	UCWL1 UP WORK, DRIVING, AND WARNING LIGHT CATALOG, 1 <sup>ST</sup> EDITION		
20	UF1210 2011 UP ANNUAL NEW ITEM SUPPLEMENT (NEW ITEM FROM 2010)		
21	UF1112 2011-2012 NEW ITEM FLYER COLLECTION		
22	UCLE02 UP LED LIGHTING PRODUCT CATALOG, 2 <sup>ND</sup> EDITION		
23	99046 UNITED PACIFIC DELUXE BINDER 3 1/2" THICK		

Any special notes / instructions for United Pacific (list here): \_\_\_\_\_

Please read the following policies for ordering catalogs:  
A) All orders for brochures, catalogs, and price books will be shipped with the customers' next regular order.  
B) If you want your brochures to ship independent of your next order, extra shipping fees will be applied and billed to your account. Please approve the shipping fees by providing a signature below.

Signature X \_\_\_\_\_

# PRODUCT INDEX

Item #	Pg #	Item #	Pg #	Item #	Pg #	Item #	Pg #	Item #	Pg #	Item #	Pg #
10018	20	20895	22	29024	13	31215	19	32719	32	36881	2
10064	20	20896	22	29025	13	31217	19	32721	32	36882	2
10109	43	20928	7	29026	12	31218	19	32722	32	36909	58
10252	43	20929	7	29040	9	31219	19	32723	32	36910	58
10253	40	20937	23	29041	11	31220	19	32727	32	36911	58
10275	43	20938	23	29042	11	31221	19	33090	44	36912	58
10277	40	21066	23	29043	11	31256	45	34249	68	36913	58
10585	42	21067	23	29044	11	31257	45	36451	18	36914	58
10587	24	21068	23	29045	9	31263	45	36541	64	36915	58
10588	24	21069	23	29045	17	31264	45	36666	46	36916	58
10589	24	21078	57	29046	12	31268	45	36667	46	36917	60
10609	42	21148	65	29047	15	31269	45	36668	37	36918	60
10660	20	21149	65	29048	14	31274	57	36669	37	36919	60
10697	20	21150	65	29049	15	31275	57	36670	37	36920	60
10712	20	21175	23	29050	15	31284	57	36671	63	36921	46
10727	22	21176	23	29051	8	31285	57	36672	63	36922	25
10769	36	21266	23	29052	8	31289	46	36673	47	36922	30
10849	20	21270	23	29053	14	31391	46	36675	47	36923	30
10860	62	21271	23	29054	14	32145	49	36676	47	36924	25
10861	62	21455	65	29055	14	32146	49	36677	29	36924	30
10878	42	23054	60	29056	12	32147	49	36678	29	36925	30
11012	68	23058	60	29060	16	32149	49	36679	30	36927	25
11013	68	23090	67	29061	16	32150	49	36680	30	36928	21
11300	35	23091	67	29062	16	32155	49	36775	50	36930	21
11310	35	23525	60	29063	16	32156	49	36776	50	36931	21
11320	35	23578	60	29064	15	32157	49	36777	50	36932	21
20290	24	29000	3	29065	17	32158	49	36781	29	36934	21
20291	28	29001	3	29066	17	32159	49	36782	29	36935	21
20292	28	29002	3	29067	17	32169	50	36783	29	36943	33
20293	28	29003	3	29070	12	32700	26	36784	29	36944	33
20345	24	29004	4	29071	17	32701	26	36785	29	36945	33
20659	24	29005	4	29072	18	32702	26	36786	29	36946	33
20704	67	29006	4	29073	18	32703	26	36851	47	36964	59
20705	67	29007	4	29090	34	32704	26	36854	59	36968	22
20732	49	29008	5	29091	34	32705	26	36855	31	36969	22
20733	49	29009	5	29092	34	32706	26	36857	31	36970	22
20739	49	29010	5	29093	34	32707	26	36869	31	36971	22
20739	49	29011	5	29094	35	32708	26	36870	31	37000	10
20758	43	29012	6	30708	44	32709	26	36871	31	37074	59
20759	43	29013	6	31207	57	32710	27	36872	31	37077	29
20842	38	29014	6	31208	58	32711	27	36873	10	37078	29
20843	38	29015	6	31209	58	32712	27	36874	10	37089	59
20846	22	29016	7	31210	19	32713	27	36875	2	37090	59
20847	22	29017	7	31211	19	32714	27	36876	2	37091	59
20847	22	29020	13	31212	19	32715	27	36877	2	37092	59
20849	22	29021	8	31213	19	32716	27	36878	2	37095	19
20893	22	29022	13	31214	19	32717	27	36879	2	37096	19
20894	22	29023	13	31215	19	32718	32	36880	2	37097	19

Item #	Pg #	Item #	Pg #	Item #	Pg #	Item #	Pg #	Item #	Pg #
37098	19	42773	10	88242	63	37132BRK	48	39440BRK	53
37099	50	42773	43	88243	63	37133B	48	39510BCK	55
37115	25	42774	10	88244	63	37133BAK	48	39551B	55
37116	46	42774	43	88245	63	37192B	47	39552B	55
37190	47	42775	43	88246	63	37194B	47	42196B	23
37191	47	42776	43	88247	63	37195B	47	42197B	23
37200	19	42777	39	90100	36	38005B	64	42212B	27
37201	19	42778	39	90626	36	38095B	53	42213B	27
37202	19	42780	60	90658	10	38095BRK	53	42220B	39
37203	19	42781	60	90660	31	38112BRK	52	42221B	39
37574	19	42782	60	99068	68	38116BRK	53	50139B	42
37575	19	50148	42	99079	28	38121BRK	53	70176-2	41
37576	19	50149	42	110114	68	38143BAK	55	70629B	61
37577	19	60039	9	110115	68	38158BAK-B	52		
38869	50	70118	18	10018P	20	38159BRK-B	52		
39117	2	70119	18	10064B	20	38161BAK-B	52		
39118	2	70120	18	10263-1Y	9	38162BAK-B	52		
40089	33	70176	41	10719B	20	38170BAK	47		
40090	33	70177	41	10748B	24	38171BRK	47		
41021	41	70265	41	21039B	38	38176BAK	52		
41069	41	70270	41	21745B	2	38177BRK	52		
41544	35	70273	41	21746B	2	38309BK	55		
41679	8	70626	61	33539B	44	38310B	55		
41680	8	70636	61	36630B	64	38311B	55		
41692	27	70642	61	36631B	64	38409BAK	51		
41693	27	70646	62	36681B	31	38411BRK	51		
42335	35	70655	62	36682B	31	38455B	37		
42356	35	70656	61	36683B	37	38455BAK	37		
42372	67	70657	62	36684B	37	38456B	37		
42374	21	70658	61	36771B	48	38456BRK	37		
42375	21	70667	61	36771BRK	48	38457BAK	51		
42392	39	70668	62	36773B	56	38458BRK	51		
42393	39	70669	61	36773BCK	56	38465BAK	51		
42394	39	70670	67	36774B	38	38466BRK	51		
42395	39	70671	67	36774BARK-B	38	38479B	38		
42396	35	71006	28	36831B	26	38551BCK	56		
42397	35	71007	28	36852B	64	38746BAK	54		
42398	32	76996	50	36853B	64	38747BRK	44		
42399	32	76997	50	36862B	26	38747BRK	54		
42400	32	76998	50	36863B	26	38770BRK	48		
42401	32	76999	50	36864B	26	38771BAK	48		
42402	66	88210	40	36926B	21	38775BAK	54		
42403	66	88215	40	36940B	46	38778BCK	56		
42406	66	88223	62	36941B	33	38828BCK	56		
42407	66	88224	63	36942B	33	38849BAK	51		
42408	66	88225	63	37128B	48	38850BRK	51		
42409	66	88226	63	37128BRK	48	38920BAK	54		
42410	66	88229	63	37129B	48	39117B	2		
42411	66	88240	63	37129BAK	48	39118B	2		
42412	66	88241	63	37132B	48	39341BAK	54		







[truck.uapac.com](http://truck.uapac.com)

3788 E. Conant St., Long Beach, CA 90808

F: 888.986.5988

T: 800.790.6988

E: [sales@uapac.com](mailto:sales@uapac.com)

 Like us on Facebook: [www.facebook.com/uapac.truck/](http://www.facebook.com/uapac.truck/)

**UF1215**  
2014-2015 NEW ITEM FLYER  
COLLECTION



710270095261